

7474 dual D edge-triggered Flip-flop IC

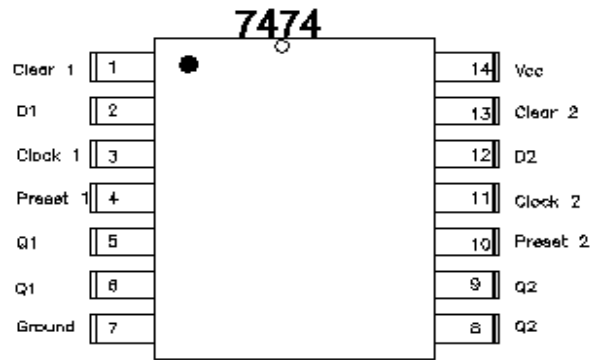

7490 Decade Counter IC

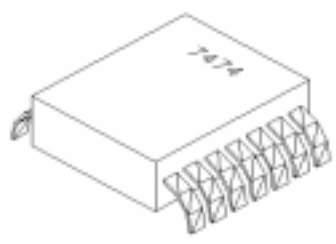
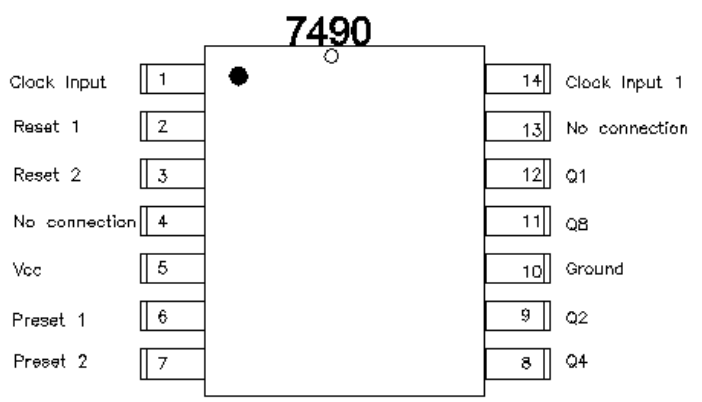
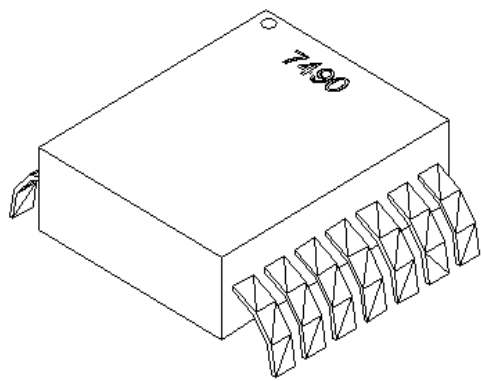

LF 351 Operational Amplifiers (Op amp)

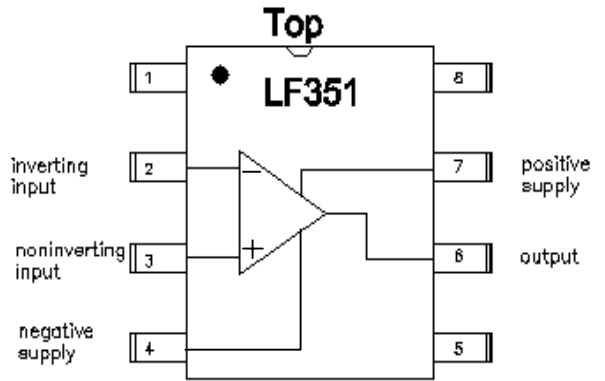
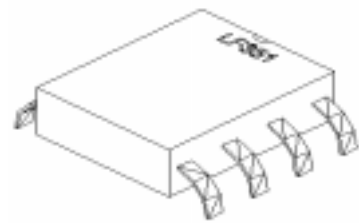

LM675 Op Amp

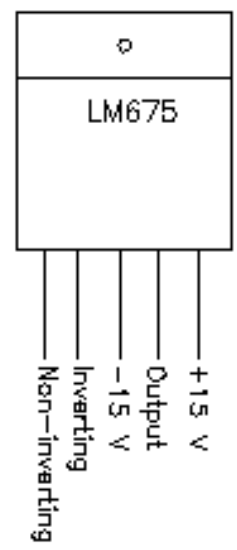
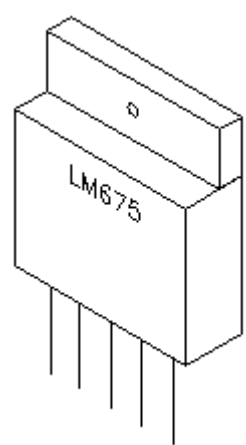

Motor/Tachometer Unit

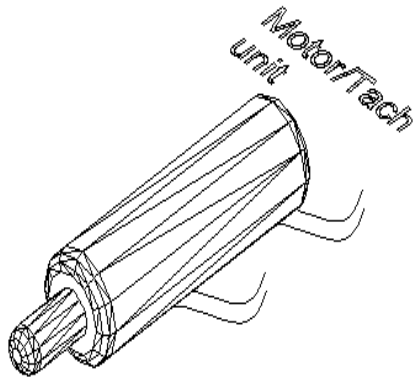

Tachometer Terminals

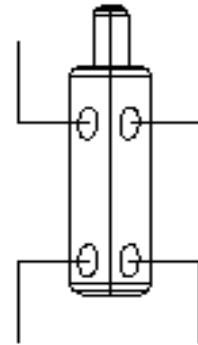

10 V (from Power Supply)

IRF 511 FET

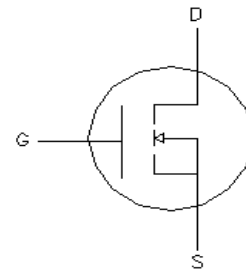
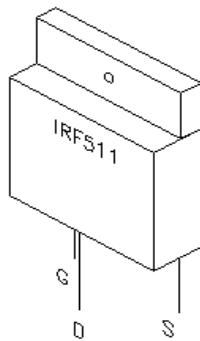

LED

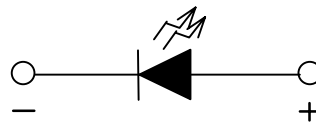
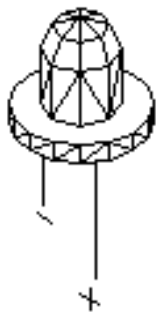

Rectifier diode

