

Designing 915MHz Oscillator  
Project Report  
EE172  
For Dr. Kwok

Prab\_, Cory J. Wong, Elena Kaye

**Purpose:**

Design, build and test a 915MHz oscillator as a part of the transmitter-receiver system.

**Design:**

The final design of the oscillator was based on the schematic given in [1] that used 915MHz SAW resonator.

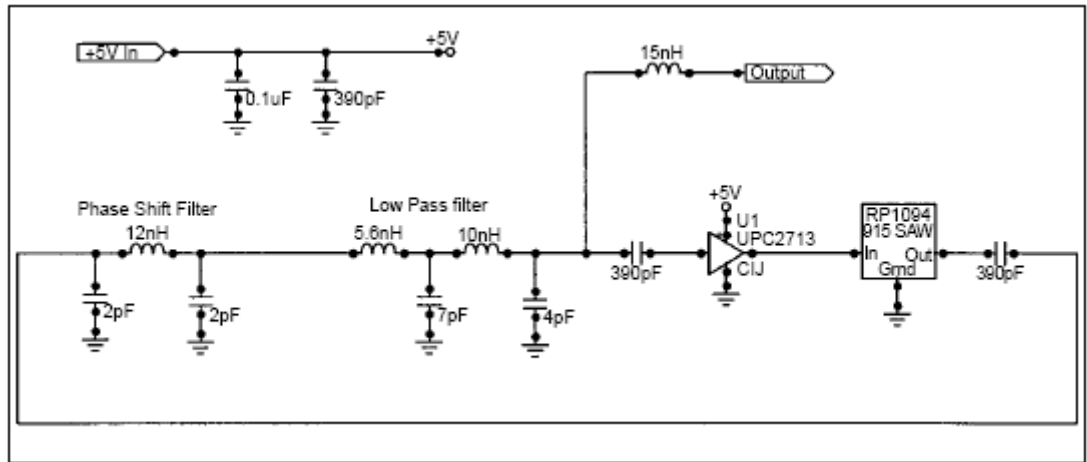

Figure 1: SAW Resonator Schematic

A brief explanation of the design stages are given below:

**Design method:**

The feedback or loop method, that places the two-port SAW resonator as an element in the feedback loop of an amplifier, was used for the oscillator analysis and design. The main conditions satisfied were:

1. A net loop gain of one or higher, or at least 0dB.
2. No phase shift in the loop.

The two critical devices in this design are the RF amplifier and SAW device. Due to limited resources, several alterations were made in the schematic shown in Figure 1.

**RFIC amplifier selection:**

There are two choices for amplification: RF transistors and RF integrated circuits. Most of RFICs have a broad frequency bandwidth and a nominal 50  $\Omega$  input and output impedance. By following the recommendations in the article [1] design, the optimal and simplest solution for the oscillator was the RFIC.

By selecting a specific amplifier, the following criteria were applied:

1. Sufficient gain at 915MHz to compensate for any losses that occur in the feedback loop.
2. Maximize input power. Some RFIC amplifiers are limited in the input power value to prevent any damage. To avoid damage to the amplifier, the following equation was used to calculate the correct input voltage level:

$$P_{\text{maxin}} \geq P_{\text{maxout}} - P_{\text{loop}},$$

$P_{\text{maxin}}$  is the maximum input power,  $P_{\text{maxout}}$ , is the maximum output power, and  $P_{\text{loop}}$  is the loss through the feedback network. Each value is expressed in dB.

### **Gain/phase vs. frequency characteristics:**

To avoid oscillations at spurious frequencies, a low-pass filter was included into the circuit. To determine the location of any spurious resonant frequencies the gain and phase of the circuit as a function of frequency needed to be measured using a network analyzer. From this, the values for the filter components could be determined.

### **Phase compensation:**

After a frequency selective filter was designed, the open loop circuit was implemented. The gain and phase behaviors, as a function of frequency, were measured again. The phase of the loop was measured with the amplifier in saturation since an amplifier's phase curve is different in saturation than that from linear operation. For the appropriate functioning of the oscillator, the loop phase must be adjusted so that it equals  $0^\circ$  at 915MHz. For two-port resonator SAW devices, the phase changes by about  $180^\circ$  near resonance.

Due to the phase shifts caused by device parasitics, transmission lines between components, the amplifier, and any other components in the loop, a point of  $0^\circ$  phase may not occur in the neighborhood of resonance. The resulting circuit may not oscillate reliably unless the loop phase is properly adjusted. Even if the circuit does oscillate, it may not be at the exact desired frequency.

Once the optimal frequency is determined, the phase through the loop at this frequency is measured with a network analyzer or through simulation. The desired phase for the phase shifting filter simply equals the measured value, so that the total phase sums to  $0^\circ$  at the optimal frequency.

### **Complete oscillator circuit:**

To complete the oscillator circuit, the phase shift filter is added in series with the feedback loop. When the open loop response is measured, the phase should be  $0^\circ$  at the desired oscillation frequency. When closed, the circuit will oscillate at the desired frequency. The output is coupled to the loop using a discrete capacitor or inductor. An inductor is often preferable because it will limit the power of the harmonics. A capacitor, on the other hand, will enhance the harmonic power over the fundamental power since the impedance of a capacitor is inversely proportional to frequency.

Another consideration for output coupling is the placement of the coupling network. By placing the coupling network after the SAW and filters, much of the harmonic content from the saturated amplifier will be suppressed.

### **Components:**

The following components were used for testing:

1. HP 8752A 300kHz – 3GHz Network Analyzer
2. Two RG 142 cables: 150 cm and 60 cm long
3. HP 8563E 9kHz – 26GHz Spectrum Analyzer
4. RG 142 cable 88cm long
5. 10dB attenuator
6. TENMA triple output DC power supply 72-4045A

The following components were used for the oscillator:

1. RP1094 915.0MHz SAW Resonator (data sheet [2])
2. Monolithic Amplifier 50Ω Broadband DC to 8GHz ERA-5
3. RF Choke 50Ω Very Wideband 50 – 10000GHz
4. R Bias resistor  $R = 57 \Omega$ , 1/8W
5. C bypass capacitor  $C = 0.02\mu\text{F}$
6. Two C-block capacitors  $C = 47\text{pF}$
7. SMA male to male on 463 Q-flex(r) cable  $\approx 20\text{cm}$  long
8. Two chip inductors – 1008 CS Series  $L = 10\text{pF}$  and  $15\text{pF}$
9. Capacitor  $C = 4\text{pF}$
10. FR4 PCB board
11. Copper tape (unknown parameters)
12. Three SMA male connectors
13. SNA type “T” adapter

### **Results:**

#### Stage 1 Selecting the amplifier:

The crystal RP1094 that the circuit was designed for has a typical gain of 8.5dB and the maximum gain of 15dB. The amplifier with the gain higher than 15dB was needed. Monolithic broadband amplifier with the typical gain of 19.5dB at  $f = 1\text{GHz}$  was selected for the circuit.

#### Stage 2 Checking the gain of the amplifier in the part of the loop:

\*\*\*\*\*schematic\*\*\*\*\*

The circuit was connected to the Network Analyzer and 6V was applied to the amplifier. The gain was measured at 915MHz:  
 $|S_{21}| = 12\text{dB}$

This gain was not high enough if the insertion loss of the resonator turned out to be maximum, 15dB.

Stage 3 Checking the gain of the loop with the crystal in it:

A resonator in series with the amplifier and the output of the oscillator were coupled and added to the loop using 15nH inductor. The resonator has a nominal insertion phase shift of 180° at resonance, and the rest of the circuit components added the phase shift, but of unknown values. The circuit was powered with 6V, thus, terminating the output port and the gain and phase were measured again.

915.00MHz	+0.33dB	-14.4°
914.92 MHz	+2.62dB	+18.8°

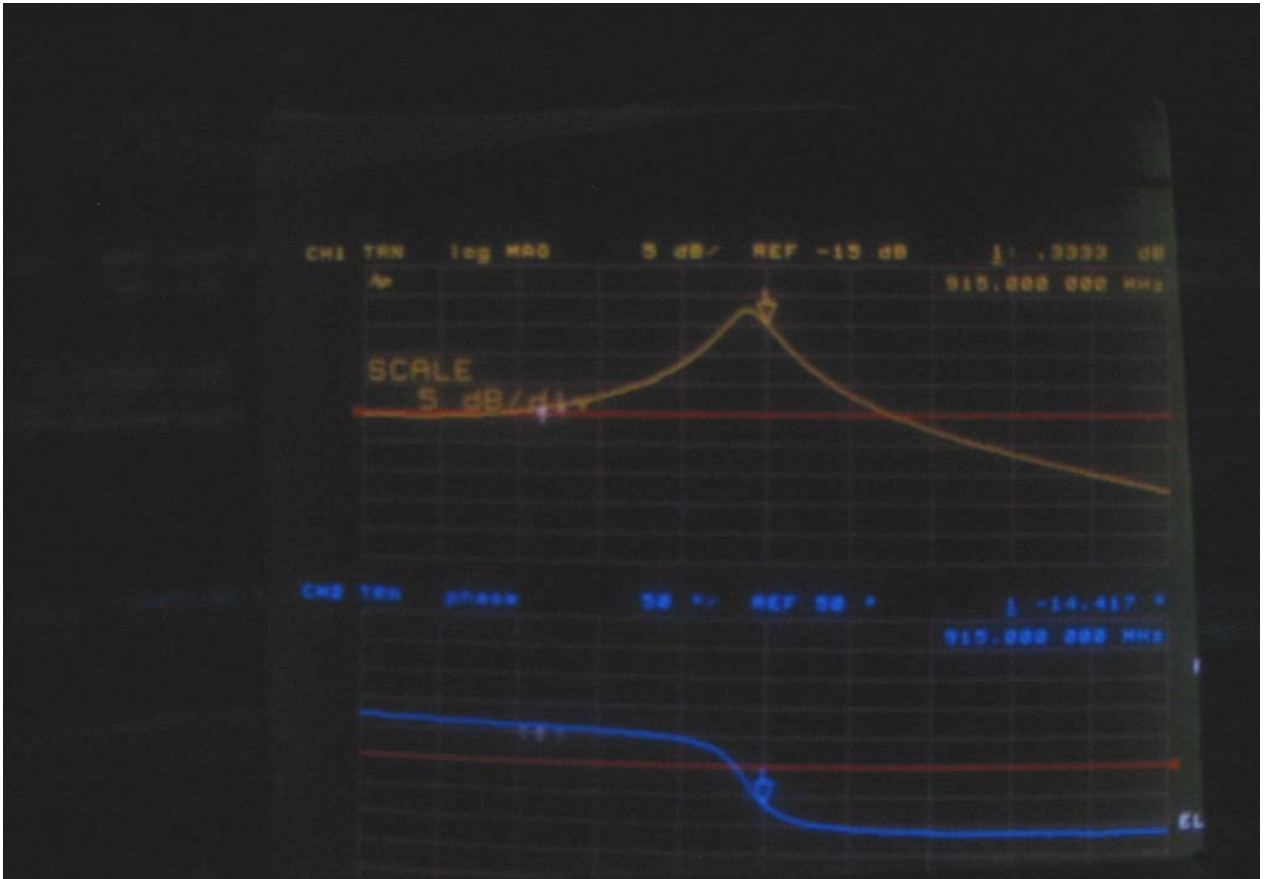

Figure 2: Gain and Phase at 915MHz (range 912 – 917 MHz):

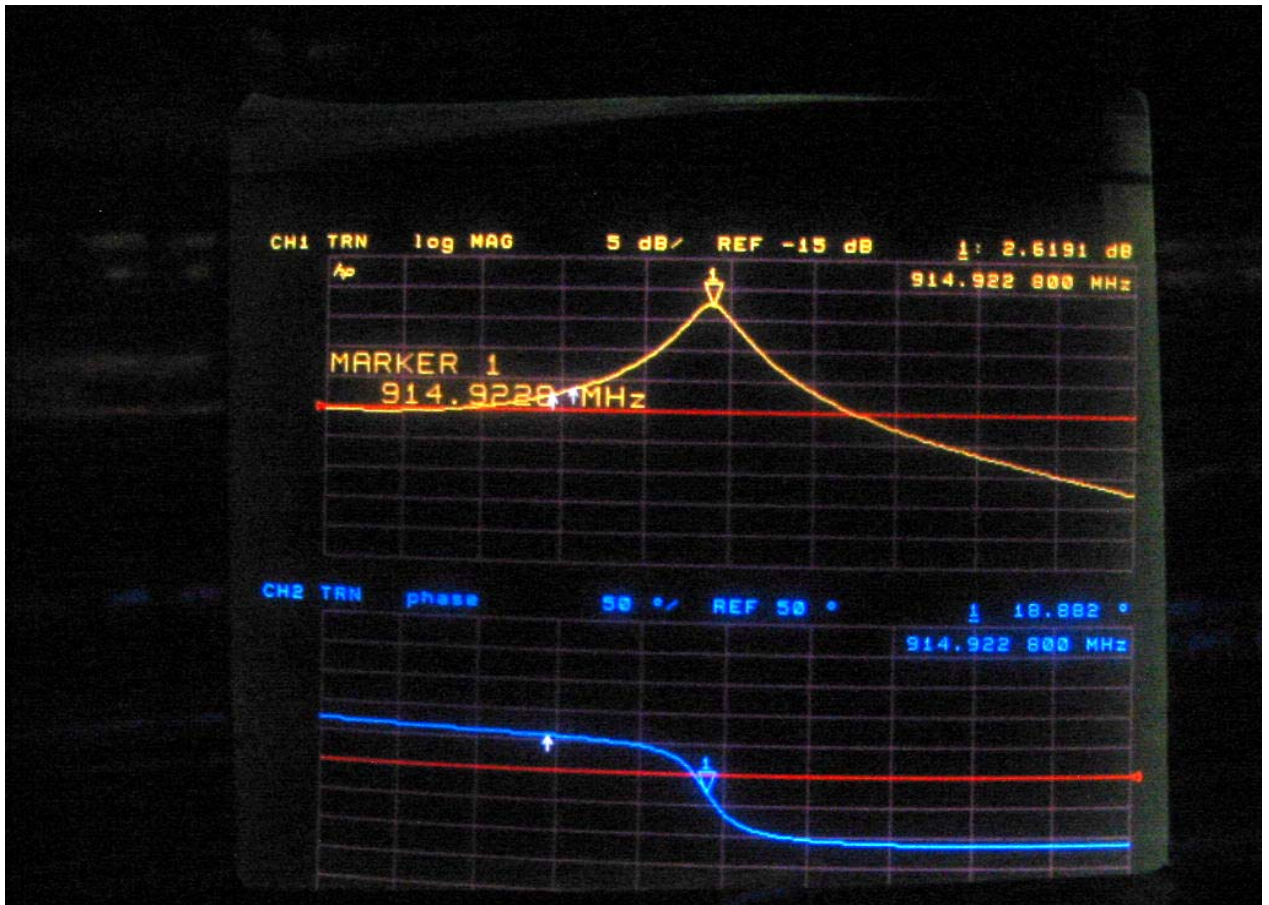

Figure 3: Peak Gain Frequency

Stage 4: Phase compensation calculations:

To bring the total phase shift to  $0^\circ$ , the phase of the loop needs to be shifted by  $-345.6^\circ$  ideally.

Instead of designing a phase shift filter, a transmission line was used to compensate the phase shift. To calculate the length on the needed transmission line (ideal) the following equations were used:

$$\begin{aligned}\Theta &= \beta l \\ \beta &= 2\pi/\lambda \\ l &= \Theta * \lambda / 2\pi \\ \lambda &= c/f = 0.32\text{m} \\ l &= 0.3\text{m} = 30\text{cm}\end{aligned}$$

Coaxial cable with  $\epsilon = 2.4$  was used, to calculate the length of the cable needed the following calculations were done:

The nominal velocity of propagation in this cable is 70.7% of the speed of light in vacuum. Using the value for  $\epsilon$ , find:

$$\begin{aligned}v &= c/\sqrt{\epsilon} \\ v &= 19.3\text{cm/nsec}\end{aligned}$$

After time equal to the full period the phase shift equals to  $360^\circ$ , to find time needed for the shift of  $345.6^\circ$ :

$$T = 1/f = 1.1\text{nsec}$$
$$t = (345.6/360)*T = 1.05\text{nsec}$$

$$\text{Length of TL} = l = v*t = 20.2\text{cm}$$

Stage 5: Phase compensation

A piece of cable (transmission line) was used to close the loop of the circuit. Various lengths of cable were used and tested. By connecting to the Spectrum Analyzer to one of the two ports of the oscillator, the output observed the frequency behavior.

<u>frequency, MHz</u>	<u>TL, cm</u>	<u>Peak</u>
912.05		50cm
914.98		25cm
915.12		20cm

Using the available cables only, the 20cm long cable was used to close the feedback loop of the oscillator.



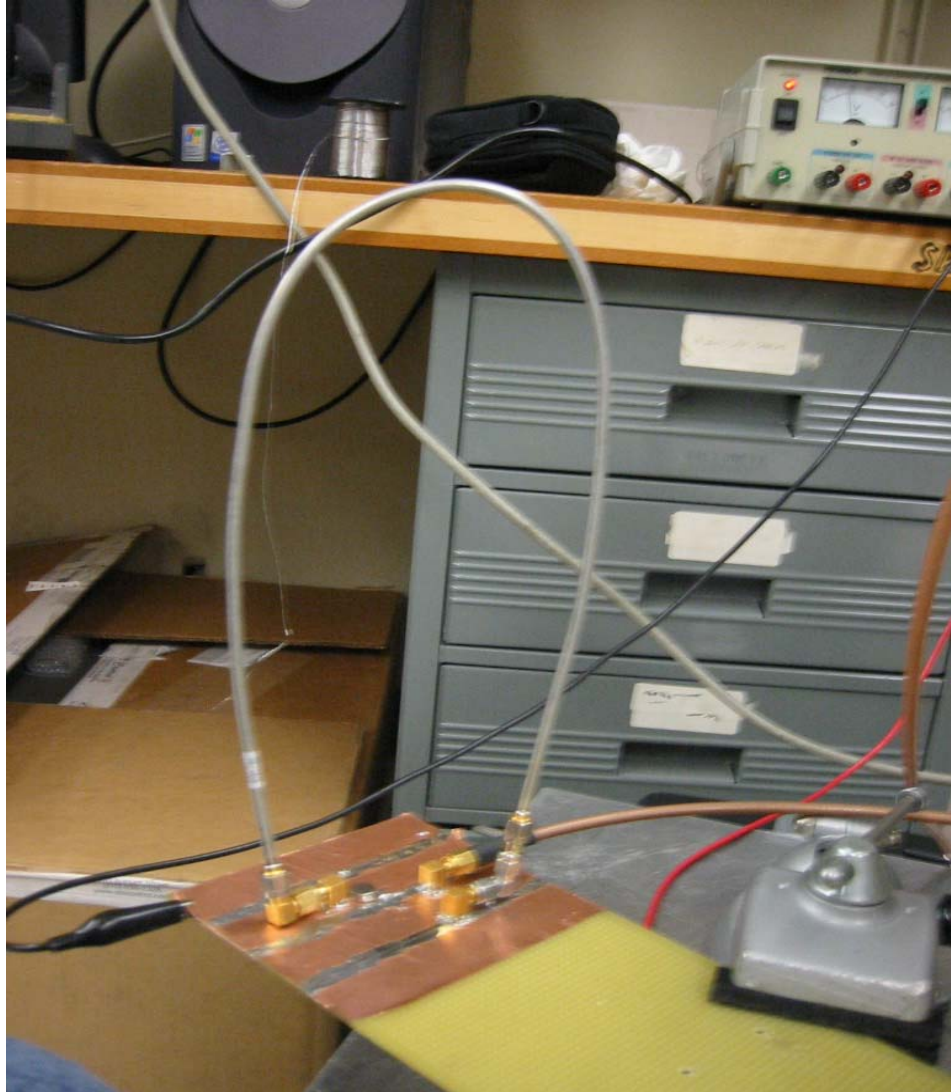

Figure 4: Test Set-Up with 50cm cable

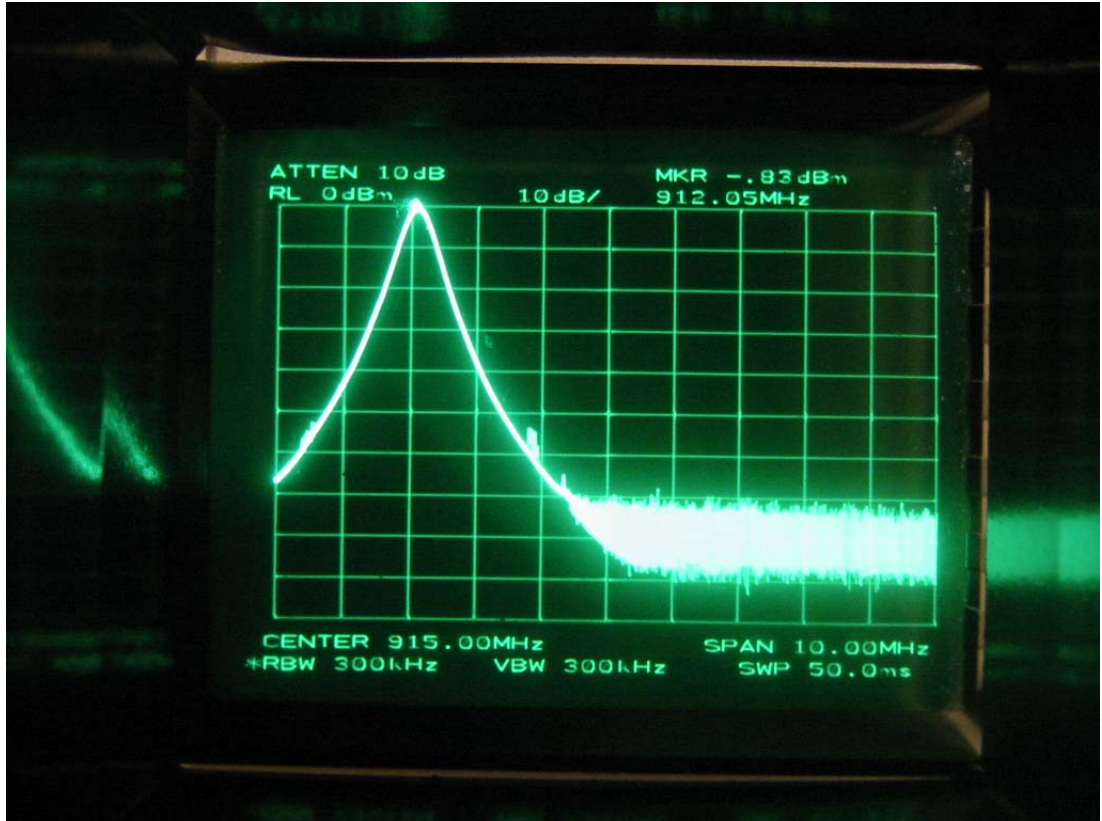

Figure 5: Oscillator Response with 50cm cable

|

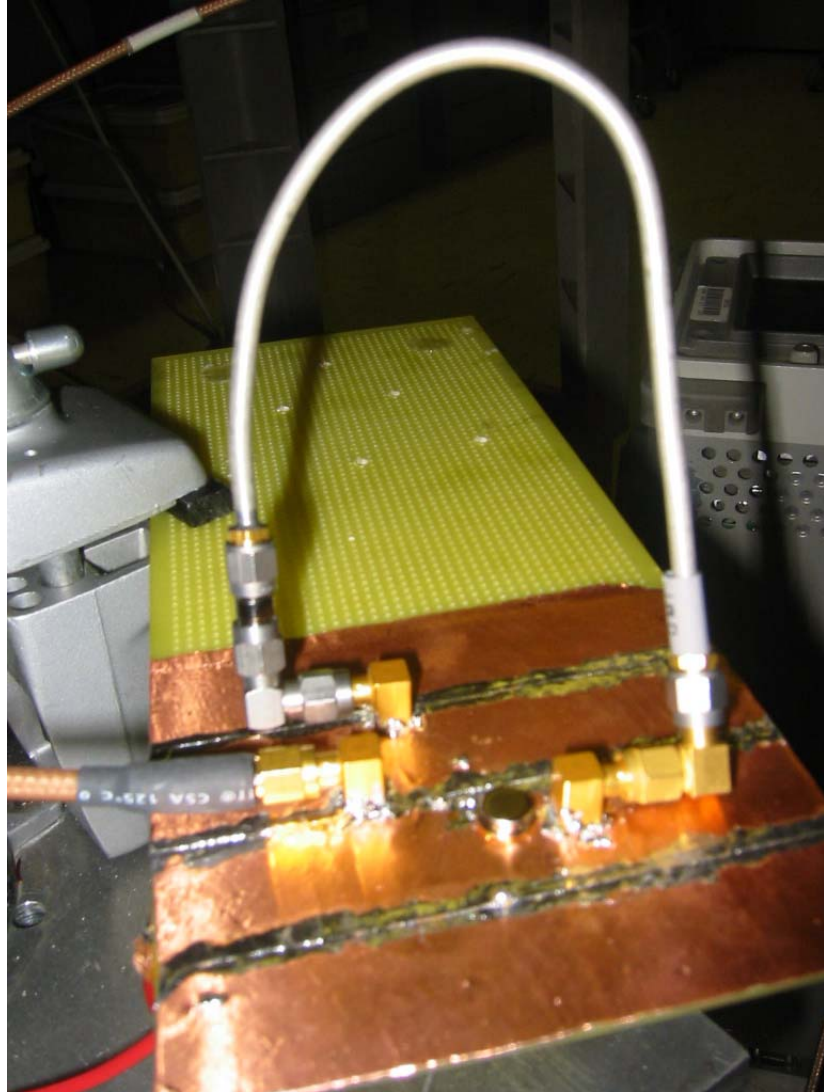

Figure 6, Test Set-Up with 25cm cable

|

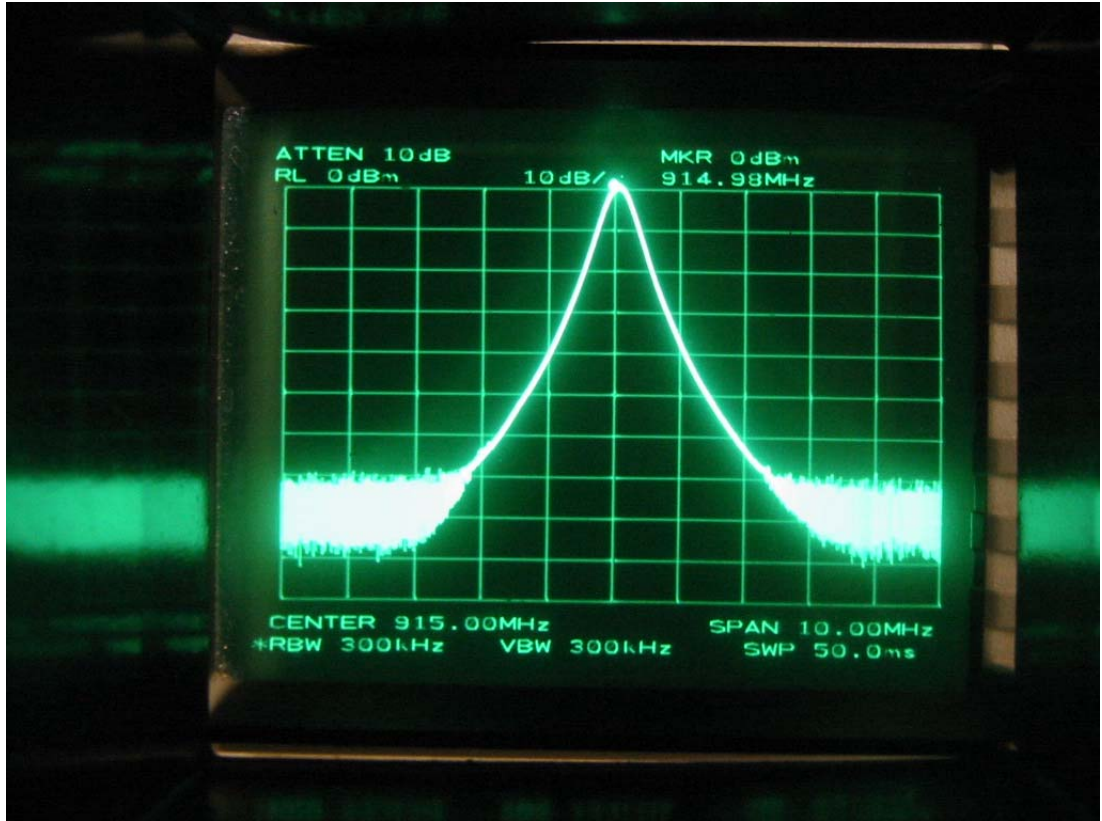

Figure 7: Oscillator Response with 25cm cable

|

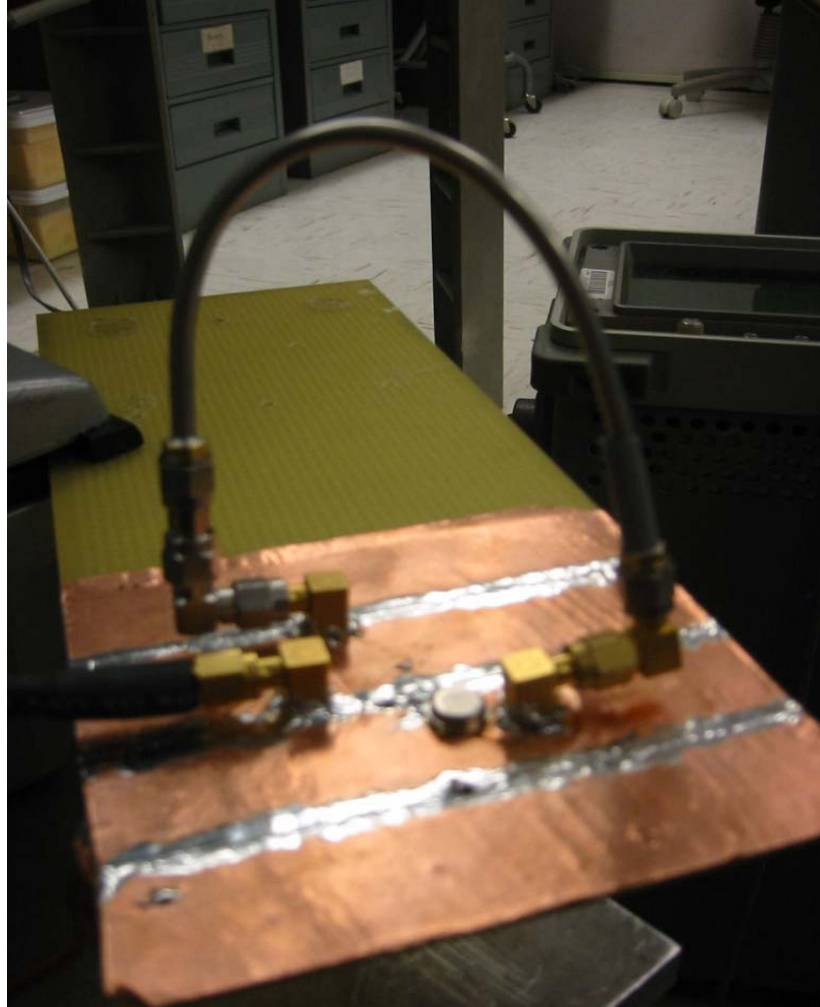

Figure 8: Test Set-Up with 20cm cable

|

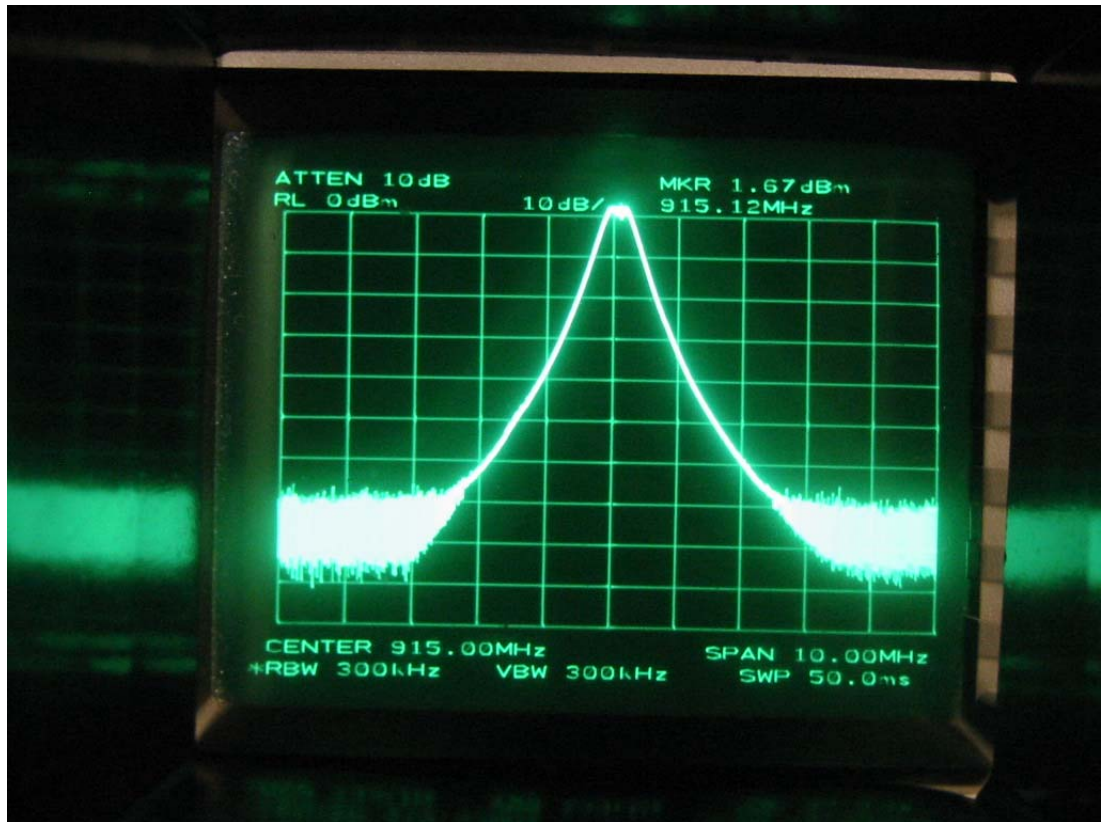

Figure 9: Oscillator Response with 20cm cable

Stage 6: Resonant frequency behavior analysis

One of the two output ports was connected to the Network Analyzer using 10dB attenuator. Increased DC voltage to the circuit from 5V to 8 V recorded the peak frequency and it's gain, and the gain of 915MHz

Table 1: Frequency and Voltage Results

DC	Peak f, M	Peak f gain, dB	915MHz gain, dB
5	0	-76	-76
5.	915.03	-10	-11.3
6	915.03	-8.83	-9.33
6.	915.05	-9.83	-10.3
7	915.08	-11.83	-13
7.	915.17	-12.17	-15.6
8	915.22	-10.67	-16.6

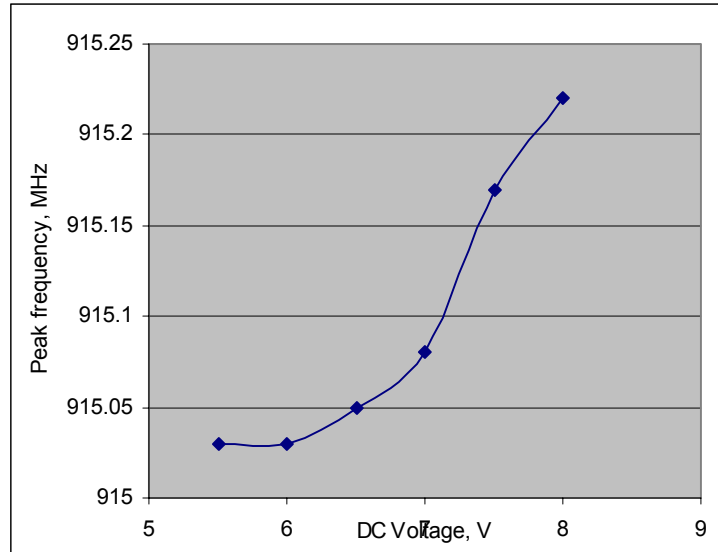

Figure 10: Peak Frequency vs. Voltage

Figure 10 shows how the peak frequency of the oscillator depends on the amplifier voltage. Around 6V of input DC voltage the frequency stays constant. But at higher input voltages, the peak frequency changes quite rapidly. These may cause unstable behavior in terms of stability with the desired frequency range; therefore, it's not recommended to apply voltage above 6V. To define the minimum voltage, use plot 1 again. It is seen that it takes 5V or more to start the oscillator.

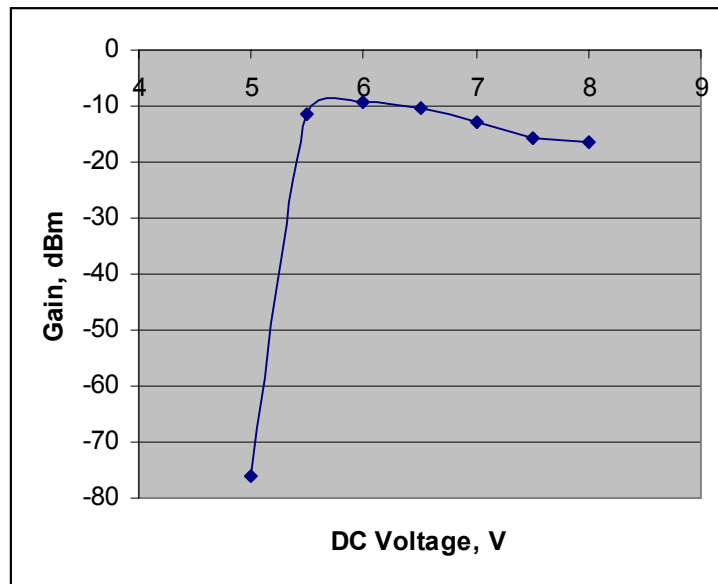

Figure 11: Gain vs. DC Voltage

Analyzing Figure 11 one can see how the amplifier is affecting the output power of the oscillator at 915MHz. It looks like the amplifier gets saturated around 6V.

Using analysis of plot 1 and plot 2, 6V was chosen as the operational voltage level of DC power supply.

Stage 7: Characterizing the oscillator

Using Spectrum Analyzer, the output power, the 3dB bandwidth and the signal-to-noise ratio (SNR) of one of the ports were measured:

$$\begin{aligned} P &= 0.16\text{dBm} \\ \Delta f &= 280\text{kHz} \\ \text{SNR} &= (70 - 75) \text{ dB} \end{aligned}$$

Quality factor was calculated for 915MHz:

$$\begin{aligned} Q &= f/\Delta f \\ Q &= 3268 \end{aligned}$$

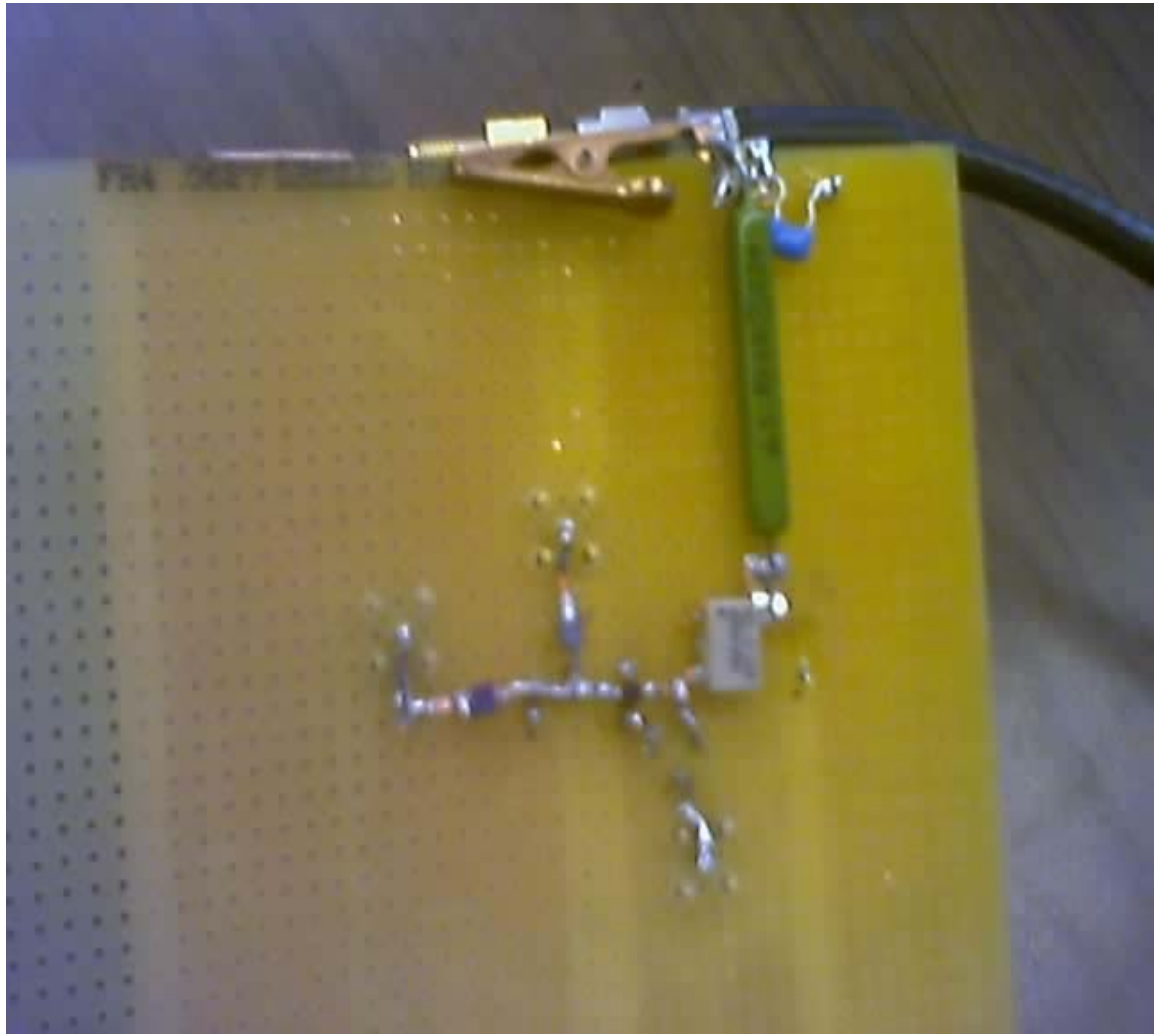

Figure 12: Final Circuit Front Layout



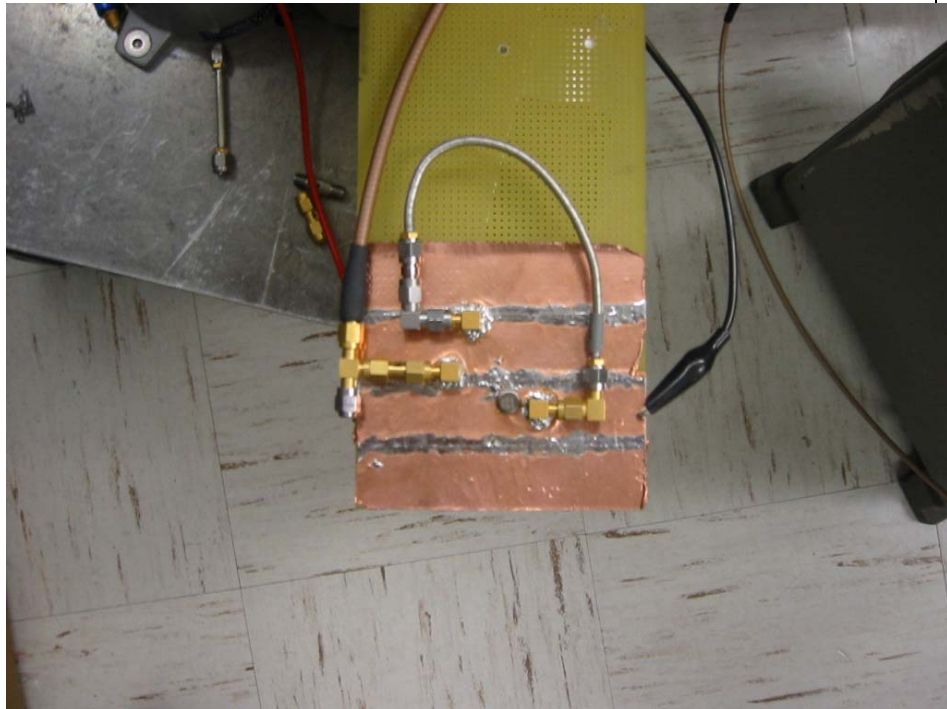

Figure 13: Final Circuit Rear Layout

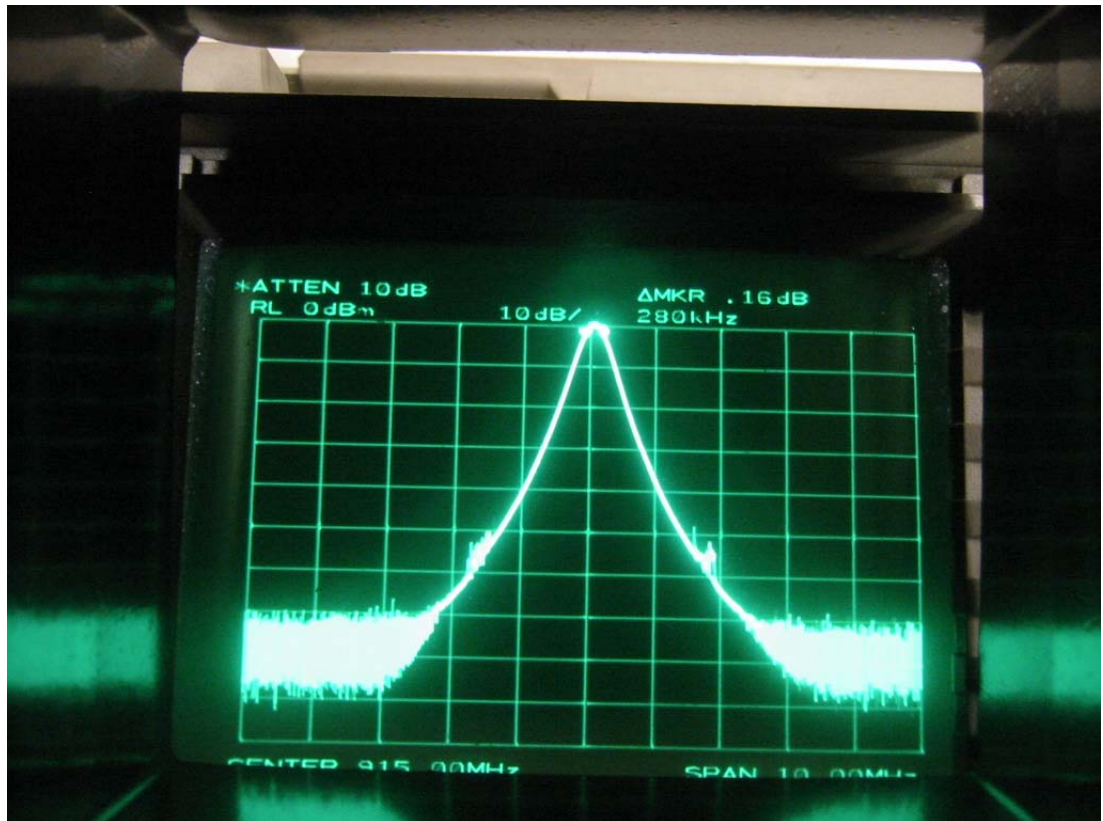

Figure 14: Spectrum Analyzer for Final Circuit:

## Error Analysis:

### Filter:

The design given in the article (what article?) suggested to use a low-pass filter that was made out of 10nH and 5.6nH inductors and 4pF and 7pF capacitors. Due to the limited resources only part of the filter was built, using 10nH and 4pF components. That affected filter performance and below S-parameters for these two cases are compared:

Original design filter with 3dB fc of about 1.1GHz

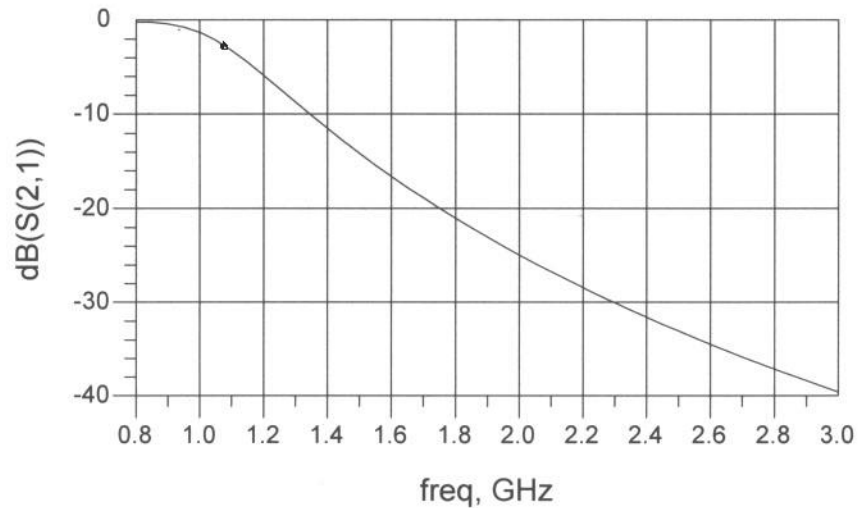
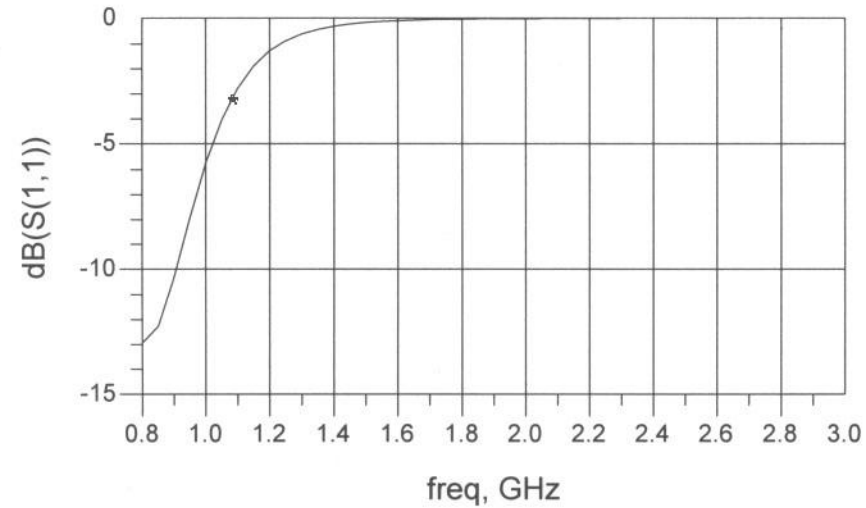
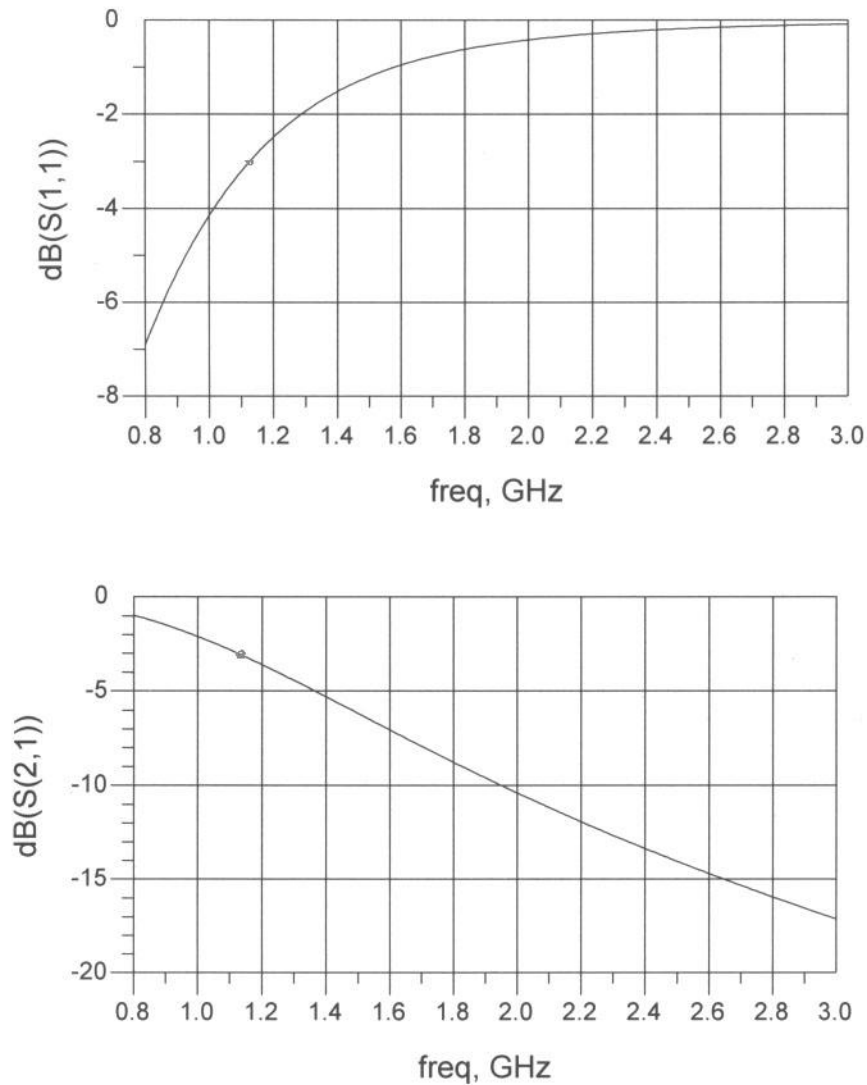

Figure 15: Reponce Curve for 1.1 GHz Filter



**Figure 16: Curve for Filter as Built**

Comparing these two filters, it was found that the filter built for the oscillator “cuts off” between 1 and 2 dB of 915MHz signal, while the original filter hardly affected the transmission of 915MHz. This is unnecessary loss and it should have been avoided.

Phase compensation:

Network Analyzer was used to measure the phase of the open loop. It was calibrated with two male - male SMA cables, and a female - female SMA adapter. That adapter was sometimes included into the loop and sometimes not. There were other adapters used to close the loop with the piece of male-male SMA cable. This introduced inaccuracy in our measurements. To estimate the error we use 2cm for the length of those adapters.

$$\begin{aligned}
 l &= 2\text{cm} \\
 v &= 19.3\text{cm/nsec} \\
 T &= 1.1\text{nsec}
 \end{aligned}$$

Then the phase shift created by each adapter is

$$\Theta = t/T*360$$

$$\Theta = 34^\circ$$

Taking this into account the phase of this circuit was measured with the accuracy of  $\pm 34^\circ$ .

#### Impedance Matching:

The resonator used in this design doesn't have  $50\Omega$  impedance at its ports. Connecting this device to  $50\Omega$  transmission line caused additional insertion loss. The article [1] provides the analysis of two different matching networks that could be used to prevent the insertion loss. One increased the Q of the device but added extra power loss, the other network had less power loss, but decreased the Q factor by 50%. According to these results it was concluded that impedance matching of this SAW oscillator will provide either little benefits to or decreases the oscillator performance.

#### Circuit board layout considerations:

The oscillator circuit layout may be reorganized to minimize the diameter of the loops that are formed by each signal trace and its return path.

#### Oscillator characteristics:

According to the RP1094 crystal data sheet the maximum bandwidth at 3dB is 300kHz.

This oscillator produces the signal with 280kHz bandwidth, which is within the range on the nominal value. It doesn't need an improvement.

The nominal Q factor of the crystal for  $50\Omega$  loaded circuit is 3700.

The measured Q factor of the oscillator is 3268. There is a way to improve the Q by impedance matching, but it may affect the output power.

The output power of this oscillator is 1.1mW if the device operates at the optimal settings.

The power level can be increased by decreasing the loss in the circuit.

Bibliography:

- [1]. "Designing an EMC-compliant UHF oscillator" by Ron F. Schmitt and John W. Allen, [www.rfdesign.com](http://www.rfdesign.com) October 2000, pp.40-54
- [2]. "Microwave Engineering" by David Pozar, 3<sup>rd</sup> edition
- [3]. "Microwave devices and circuits" by Samuel Y. Liao