

TEI-SJSU High Tech Tax Institute (31st Annual)

Repatriation Strategies vs. Reinvestment Overseas

Nick DeNovio, Latham & Watkins LLP

Lindsey Newbern, PricewaterhouseCoopers LLP

Jimmy Man, Deloitte Tax LLP

Outline of Topics

1. Overview of important developments in IRS/Treasury guidance over last decade.
 - a. Repatriation Transactions
 - b. Section 956
2. Accounting for Income Taxes
 - a. Current Environment (SEC, PCAOB)
 - b. Indefinite Reinvestment Accounting Issues
 - c. What are external auditors looking for (and doing)
3. Other Repatriation Approaches
 - a. IP Sales
 - b. Section 304
 - c. Holding Companies

Repatriation Transactions

A Brief History of Repatriation Transactions:

- Last decade has seen move and countermoves by Corporate taxpayers and IRS/Treasury
- Move: structures to utilize pre- or post-deal integration and other techniques to repatriate cash or move debt offshore, in each case in tax efficient manner and often to fund U.S. deals
- Countermove: IRS Notices, Regulations, CCAs, court challenges, etc. (as recent as Sept. 2015)

Cash Triangular B Reorganization

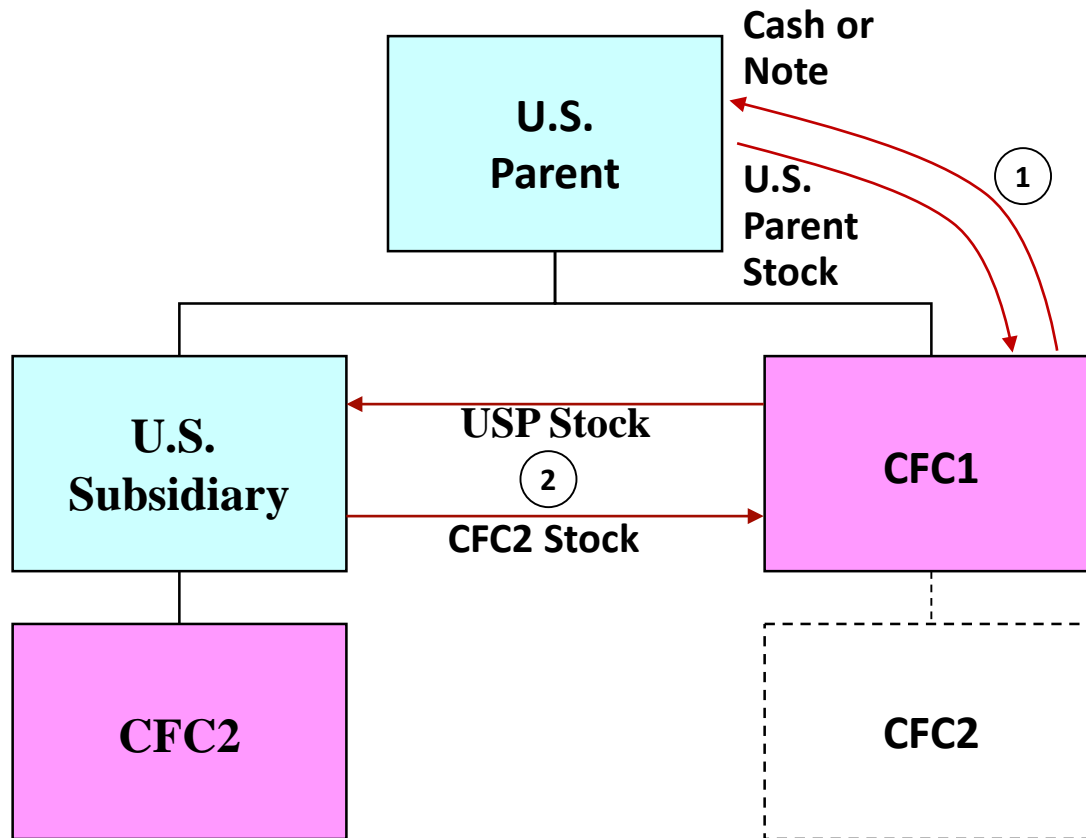

1. CFC1 purchases U.S. Parent stock for cash or note.
2. CFC1 then uses U.S. Parent stock to acquire CFC2 from U.S. subsidiary.

CounterMove: IRS issues series of Notices and eventually Treas. Reg. § 1.367(b)-10, addressing “Killer B” transactions. Step 1 creates dividend. Note: Regulations do not apply unless transaction is Reorganization.

Cash D Reorganization

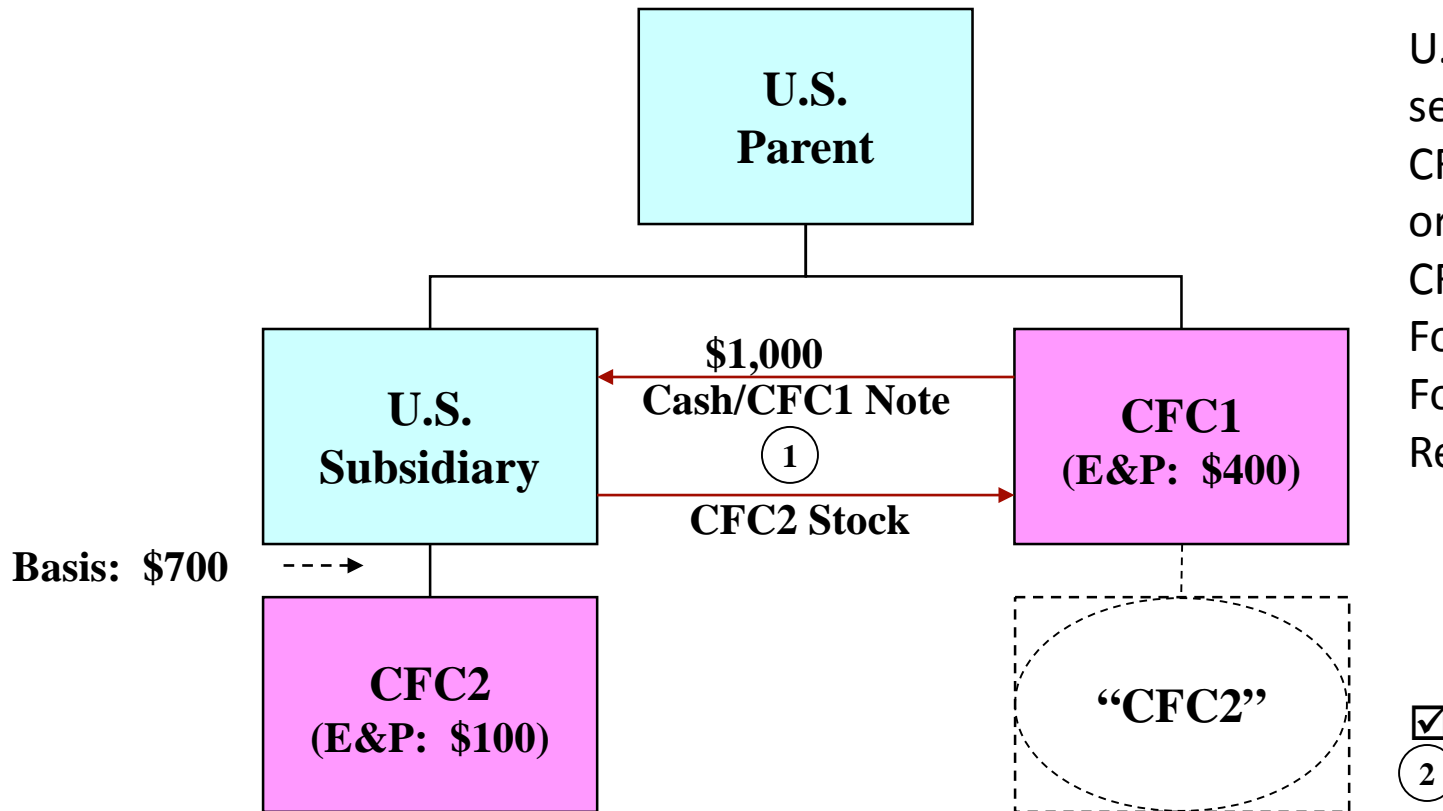

U.S. Subsidiary sells CFC2 to CFC1 for cash or a note. CFC2 files CTB. Foreign-to-Foreign Reorganization.

Not really a “repatriation” technique, but see Obama Greenbook Proposals to repeal “boot within gain” rule.

Other Transactions

Transactions designed to access overseas cash to purchase a U.S. Target Company. Common elements:

1. Use of Code Section 367(d) to defer income recognition on repatriation (in lieu of dividend) or shield completely for goodwill/going concern (GW?GCV).
2. Avoid Section 956 inclusion.
3. Boot Within Gain Rule.

Outbound Asset Reorganization in Exchange for Cash

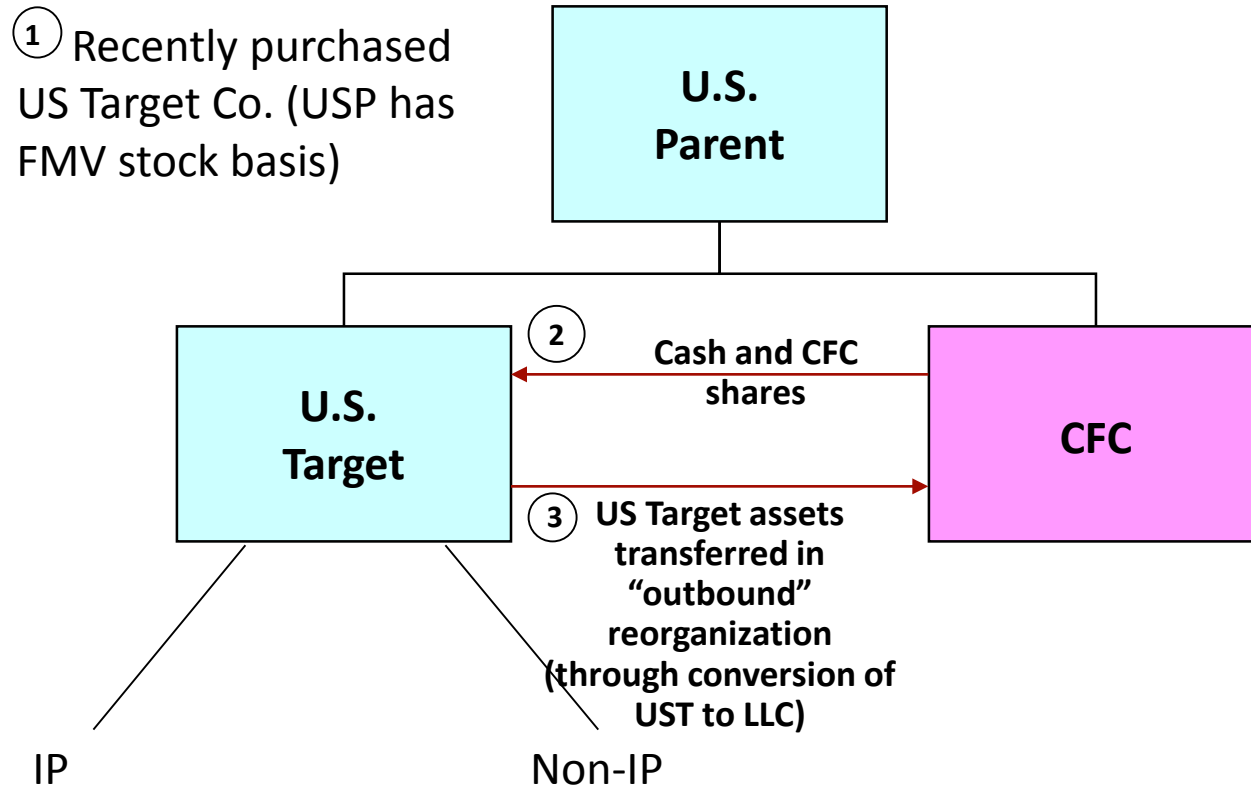

Cash in Step ② would not result in full current taxation through combination “boot within gain” rule and Section 367(d). Income inclusion over life of transferred IP.

Outbound Asset Reorganization in Exchange for Debt Assumption

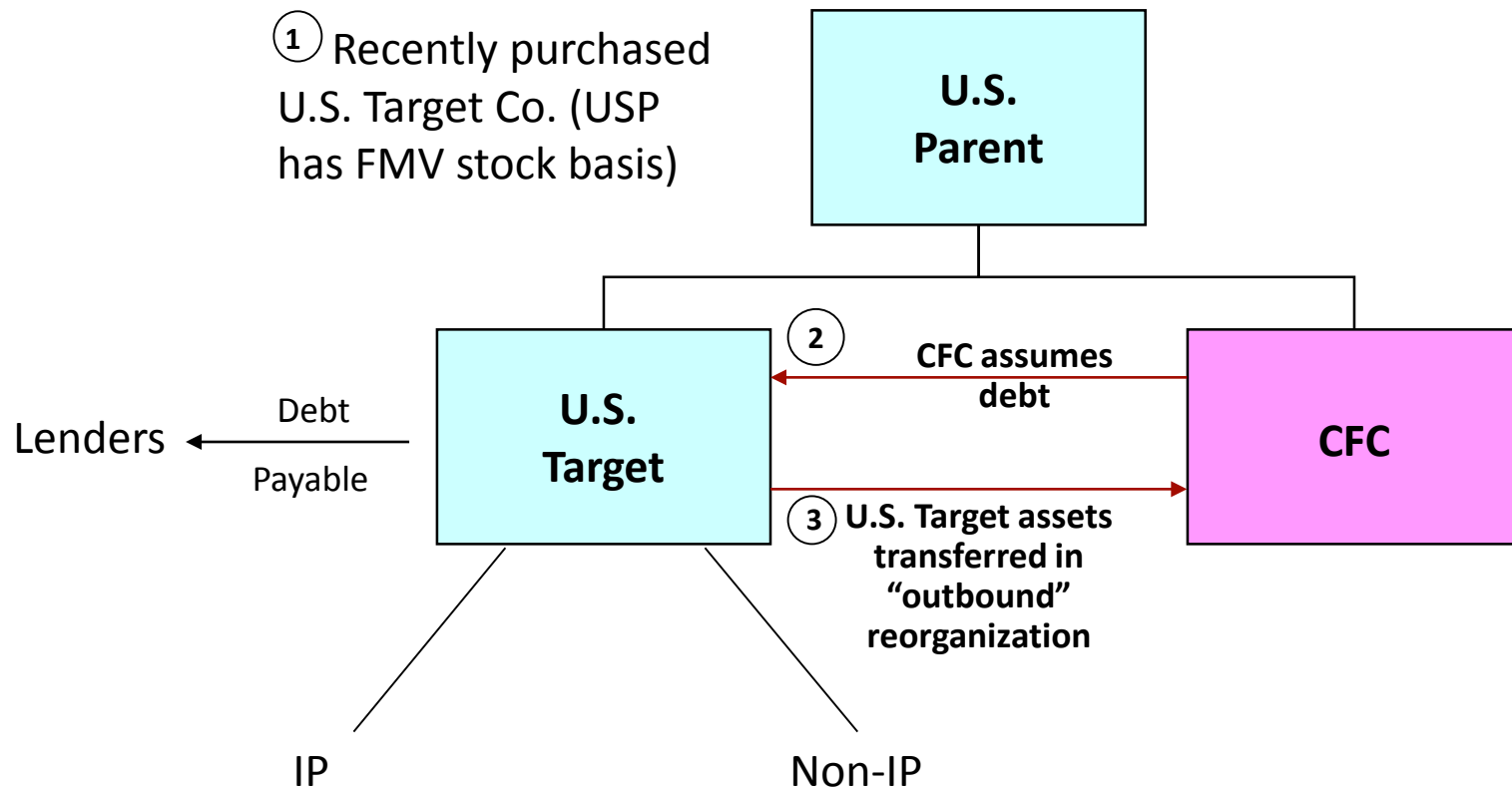

Debt assumption in Step ② would not result in full current taxation. Section 304 does not apply. Again, "boot within gain" rule and Section 367(d). Income inclusion over life of transferred IP.

CFC Uses Cash to Acquire U.S. Target; Followed by Outbound Reorganization of U.S. Target

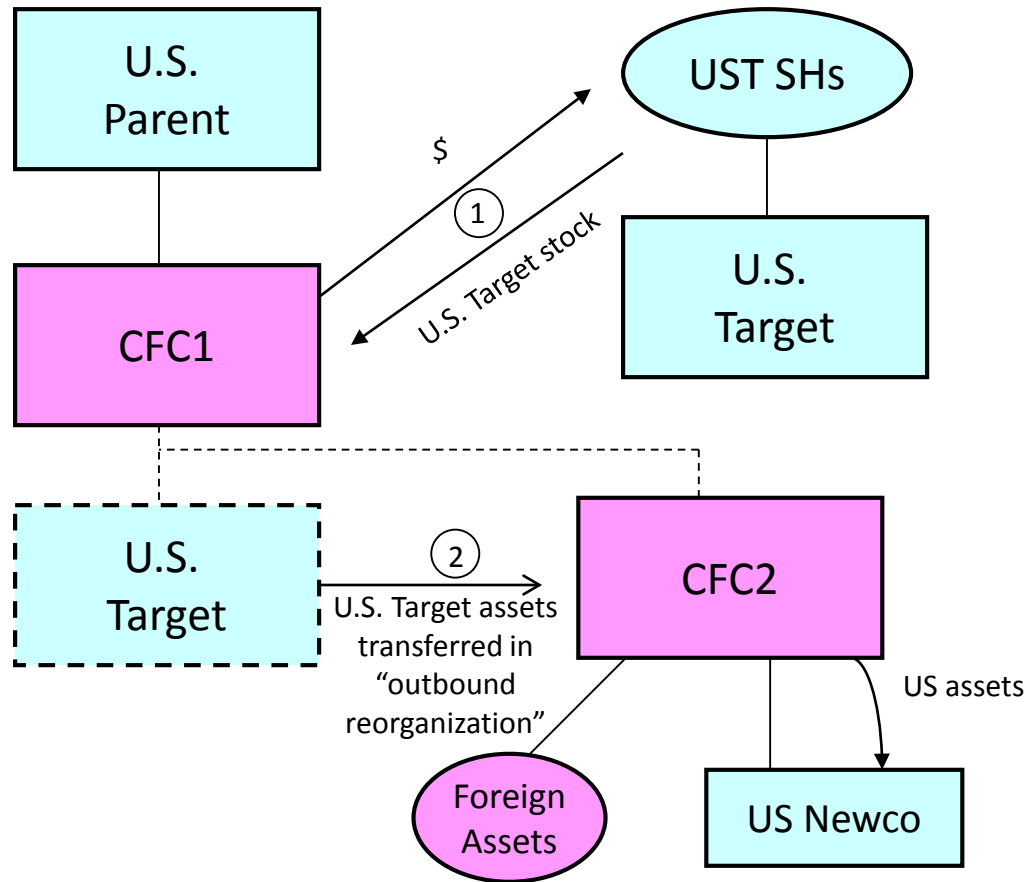

Section 956 avoided by having U.S. Target reorganized prior to quarter-end. Section 367(d) consequences. See CCA 201321018.

Countermove: Notice 2012-39

- July 13, 2012: IRS and Treasury published Notice 2012-39 to address “transactions that raise significant policy concerns.”
- Applies to transactions occurring on or after July 13, 2012.
- Fundamental Points:
 1. Cash received from CFC is treated as prepayment (currently taxable) of Section 367(d) amount.
 2. “Nonqualified debt” assumed by CFC is treated as prepayment (currently taxable) of Section 367(d) amount.
 3. Outbound reorganization of U.S. Target following its purchase by a CFC results in accelerated taxation under Section 367(d) because of no U.S. “qualified successor” for Section 367(d) inclusions.

Countermove: New Section 367(d) Regs

- Released September 2015 (proposed to be effective on such date, despite proposed form)
- Eliminate the favorable treatment afforded FGW-GCV by removing the FGW-GCV exception under section 367(d) and limiting the scope of the ATB exception under section 367(a) generally to certain tangible property and financial assets
- Thus, under the proposed regulations, upon an outbound transfer of FGW-GCV, a U.S. transferor will either (i) currently recognize gain realized under section 367(a) or (ii) annually include an amount in gross income under section 367(d)
- Proposed Regulations basically tell taxpayers: (i) recognize immediate gain with respect to that intangible property under section 367(a), or (ii) choose to apply section 367(d) to such property and have income over the life of IP

Section 956

The 956 Amount

The 956 Amount is:

(1) the excess (if any) of:

(A) such U.S. shareholder's pro rata share of the average of the amounts of United States property ("U.S. Property") held (directly or indirectly) by the CFC as of the close of each quarter of such taxable year, over

(B) the amount of earnings and profits described in Code § 959(c)(1)(A) with respect to such U.S. shareholder, or

(2) such U.S. shareholder's pro rata share of the applicable earnings of such CFC.

Mechanics

1. Adjusted Basis. The amount of U.S. property is the **ADJUSTED BASIS** of such property as determined for purposes of computing earnings and profits, reduced by any liability to which the property is subject.
2. Average of Quarterly Measurements. In the pre-1993 version of Code § 956, the computation of the 956 Amount considered the U.S. Property owned at the end of the taxable year by a CFC. This test was subject to controversy (i.e. successive short-term loans viewed by IRS as to avoid the yearly measurement). See, e.g., Rev. Rul. 89-73, 1989-1 C.B. 258; Jacobs Engineering Group, Inc. v. U.S., 79 A.F.T.R.2d (RIA) 1673 (DC CA 1997), aff'd 83 A.F.T.R.2nd (RIA) 1453 (9th Cir. 1999). In 1993, to address these perceived abuses, Congress revised the computation for the 956 amount to consider the average amount of U.S. property owned at the end of each quarter.

Mechanics (cont.)

3. Previously Taxed Income Limitation. Once the four quarterly measurements have been averaged, such average amount is then reduced by the U.S. shareholder's previously taxed income ("PTI") account as defined by Code § 959(c)(1)(A).
4. Applicable E&P Limitation. The resulting amount is then limited by the amount of the current and accumulated earnings and profits of the CFC (reduced by distributions made during the taxable year and previously taxed income as described in Code § 959(c)(1)) ("Applicable E&P").
5. Computational Example.

Average U.S. Property:	\$200
PTI:	\$ 50
Excess:	\$150
Applicable E&P:	\$135
956 Amount:	\$135

Definition of U.S. Property

1. Definition. U.S. Property generally includes these types of property:
 - Tangible property (real and personal) located in the United States
 - Stock of a domestic corporation or obligation of a United States person each of which is a U.S. Shareholder or bears a 25% ownership connection to the CFC (Note important exclusions below, re: obligations)
 - Any right to use in the United States of (A) a patent or copyright, (B) an invention, model, or design (whether or not patented), (C) a secret formula or process, or (D) any other similar property right, which is acquired or developed by the CFC for use in the United States.
2. Exceptions. The statute provides various exceptions to this general definitions. For example, deposits with a bank do not constitute U.S. Property.

Definition of U.S. Property (cont.)

3. Marketable Securities Exception. An exception is provided for an obligation of a U.S. person to the extent the principal amount of the obligation does not exceed the fair market value of readily marketable securities sold or purchased pursuant to a sale and repurchase agreement or otherwise posted or received as collateral for the obligation in the ordinary course of its business by a U.S. or foreign person which is a dealer in securities or commodities.

4. Exception for U.S. Property Acquired Prior to CFC Status. An exception is provided for U.S. property which was acquired by a CFC before the first day on which the corporation was treated as a CFC. This exception is limited to the applicable earnings of the CFC accumulated before the first day on which it was treated as a CFC.

Definition of U.S. Property: Summary

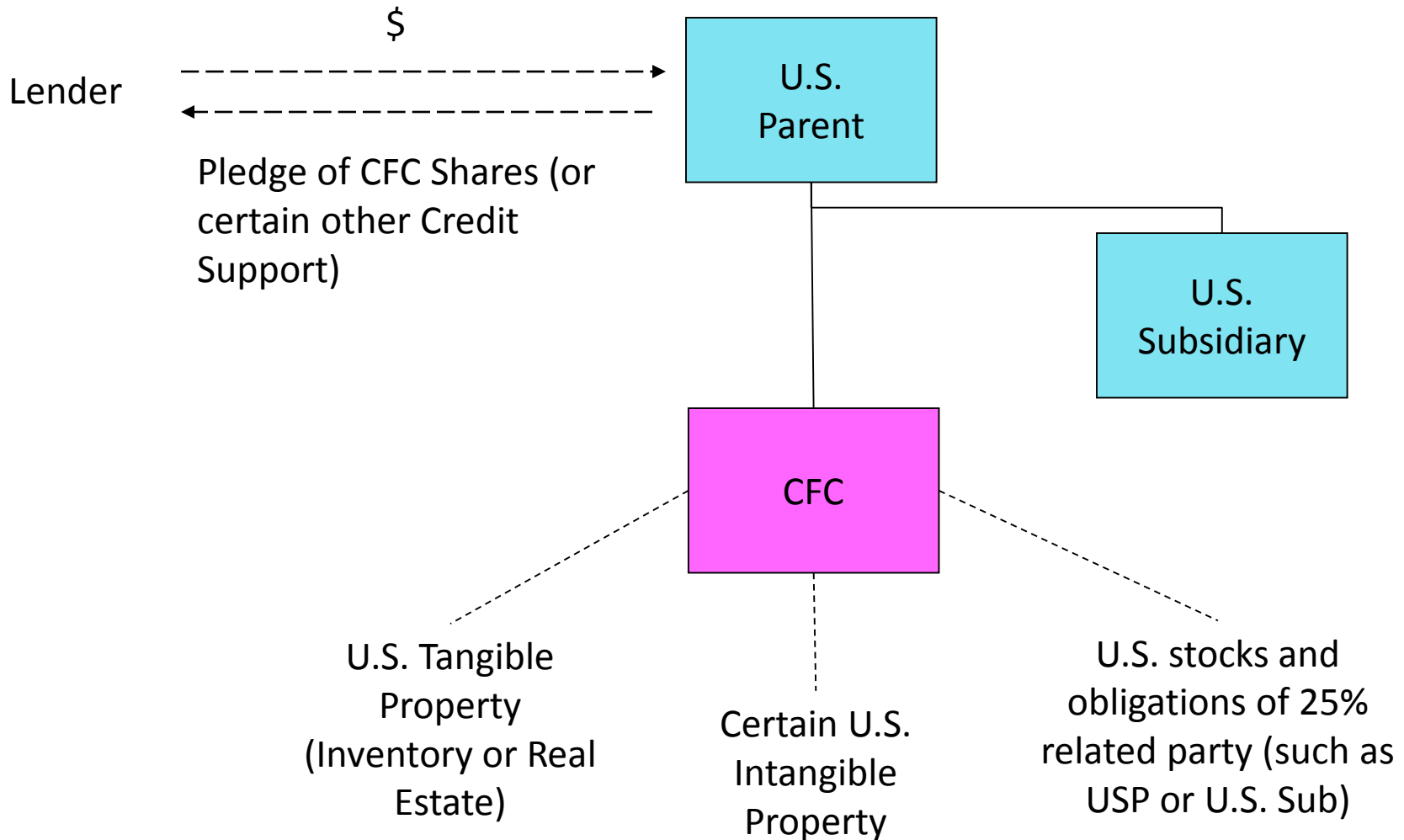

Obligation of a U.S. person

1. Definition. An obligation of a U.S. person is essentially any form of indebtedness of a U.S. person (including certain pledges and guarantees as discussed below). Clearly, a loan from a CFC to its U.S. Parent is an Obligation of a U.S. Person.
2. Direct Pledge or Guarantee by CFC. A CFC is treated as holding an obligation of a U.S. person if such CFC is a pledgor or guarantor of such obligation. This provision often creates conflict between borrower's counsel and lender's counsel.
3. Indirect Pledge or Guarantee by CFC. If the assets of a CFC serve as indirect security for an obligation of a U.S. person, then the CFC is considered the pledgor or guarantor of such obligation.
 - Shareholder Pledge of CFC Stock. A pledge of at least 66 2/3 percent of the stock of a CFC as security for a loan accompanied by negative covenants effectively limiting the CFC's ability to dispose of its assets and incur liabilities outside of the ordinary course of its business is treated as an indirect pledge of the assets of the CFC.

Obligation of a U.S. Person (cont.)

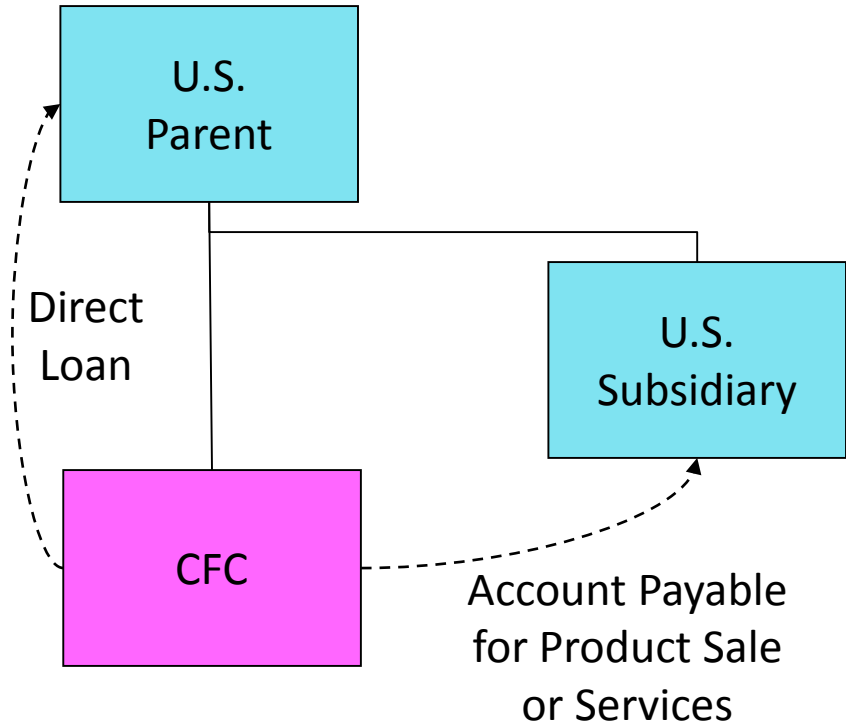

Type of Obligations:

1. Direct loan from CFC to U.S. Cos. Problem
2. CFC sells or processes property to/for U.S. Cos. U.S. Co. has account payable. Depends on "ordinary and necessary".
3. CFC provides services to U.S. Cos. U.S. Co. has account payable. Depends on "ordinary and necessary". But 60-day safe harbor.

Anti-Abuse Rule

1. A CFC is considered to hold indirectly an investment in U.S. Property held on its behalf by a trustee or a nominee.
2. At the discretion of the IRS, a CFC is considered to hold indirectly an investment in U.S. Property acquired by any other foreign corporation that is controlled by the CFC, if one of the principal purposes for creating, organizing, or funding such other foreign corporation is to avoid the application of Code § 956 with respect to the CFC.
 - A foreign corporation is controlled by the CFC if they are related under Code § 267(b). Attribution rules apply for this purpose.

Anti-Abuse Rule (cont.)

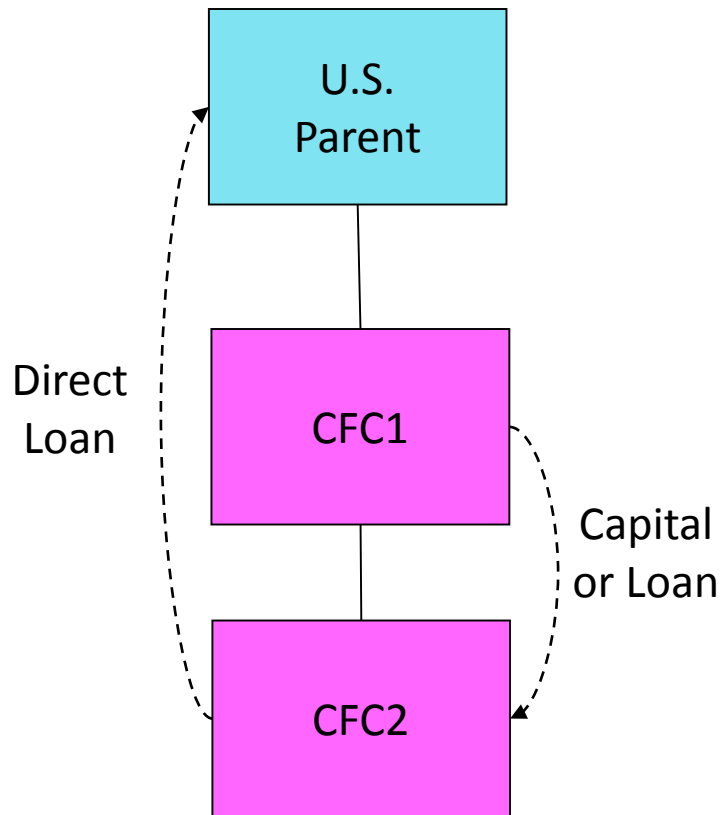

General Anti-Abuse Scenario:

1. CFC1 has cash and applicable E&P
2. CFC2 is newly formed with no applicable E&P and uses cash received from CFC1 to make a direct loan to USP

Other Section 956 Guidance

3. Partnerships. A CFC that is a partner in a partnership is treated as owning its proportional share of any property held by the partnership that would constitute U.S. Property in the hands of the CFC. See Treas. Reg. §1.956-2(a)(3).

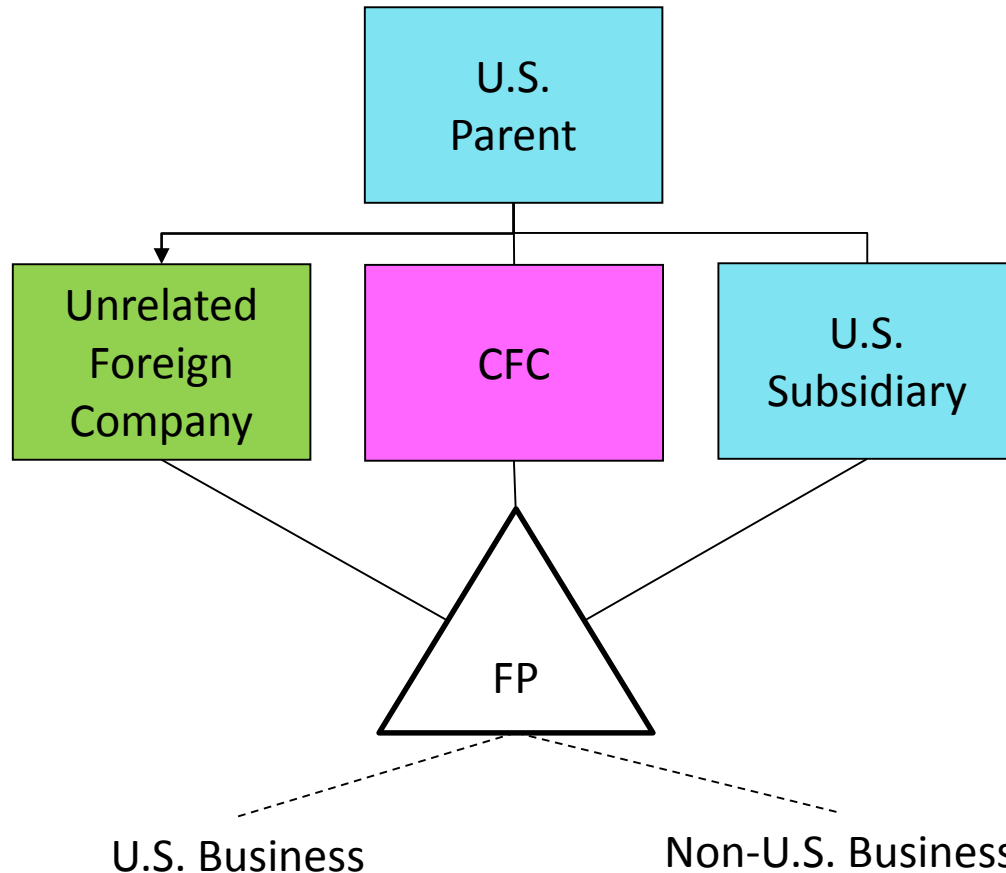

Section 956 Temporary and Proposed Regulations

1. Released September 1, 2015.
2. Proposed Regs treat an obligation of a Foreign Partnership as an obligation of its partners. A U.S. Partner in such a partnership could be treated as a U.S. obligor under Section 956.
3. Temporary regulations expand Anti-Abuse rule discussed above to certain partnership transactions.

Section 956 Temporary Regulations

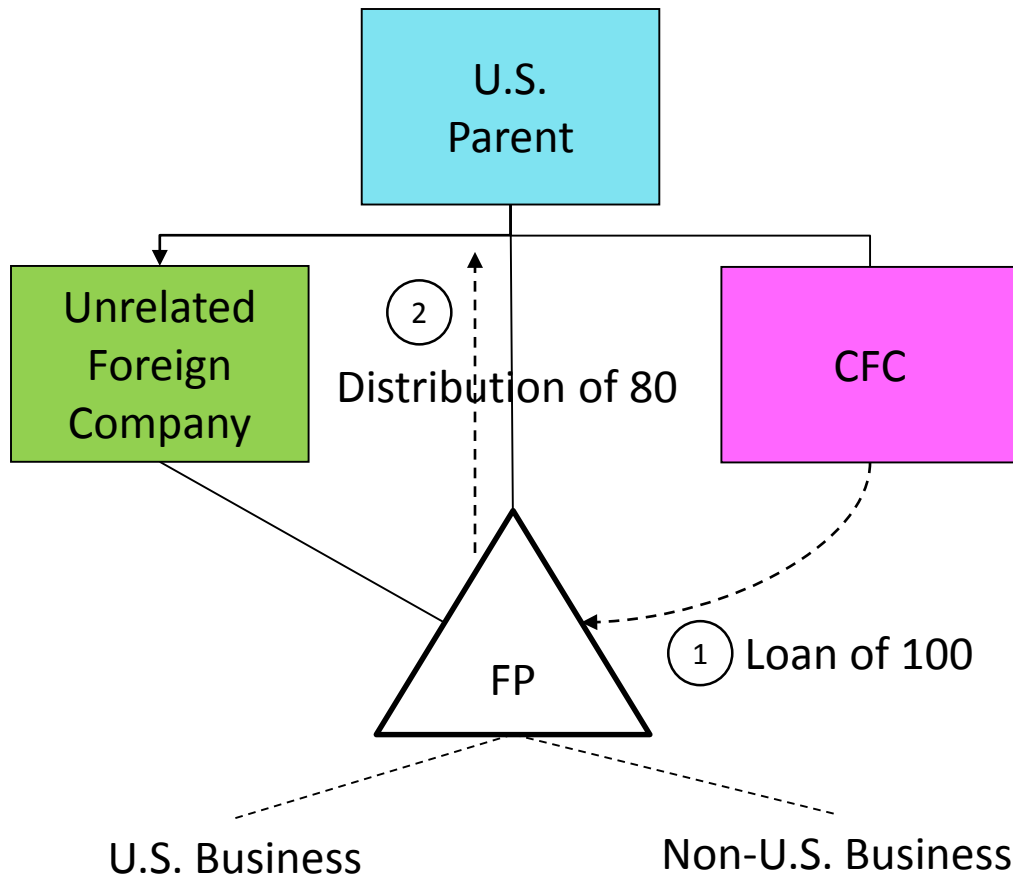

General Application of Temporary Regulations:

1. CFC loans 100 to FP
2. FP distributes 80 to U.S. Parent

Result: FS treated as holding 80 of US Property as FP would not have made distribution to U.S. Parent but for Loan from CFC

Section 956 Proposed Regulations

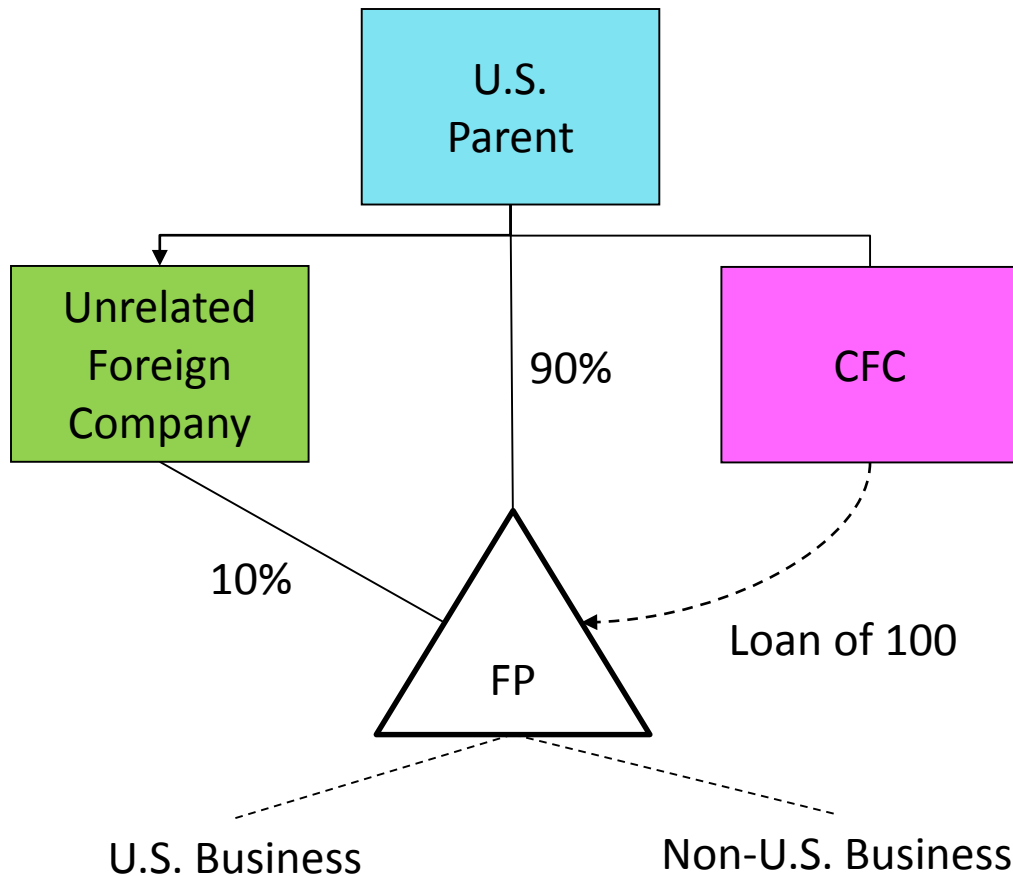

General Application of Proposed Regulations:

1. CFC loans 100 to FP

Result: USP is treated as attributed 90 of obligation irrespective whether there is a distribution made to U.S. Parent. Accordingly, CFC has 90 of US Property.

Accounting for Income Taxes

Current Environment – In the News

Repatriation in the news

- “US Companies Are Stashing \$2.1Trillion Overseas To Avoid Taxes” (Bloomberg 3-4-15)
- “When Taxes and Profits Are Oceans Apart” (NYT 7-05-14)
- "Bring Back Our Dollars: Lululemon’s Overseas Cash is Coming Home " (WSJ 6-13-14)
- "EBay to Take \$3 Billion Tax Charge" (WSJ 4-29-14)
- "Overseas Earnings Continue to Grow" (WSJ 3-31-14)

Current Environment – at Regulatory Level

Focus of politicians, standard setters, and regulators

- Heightened focus on accessing foreign earnings and tax planning (e.g., inversions)
- FASB: Indefinite reinvestment assertion added to the disclosure framework project (considering adequacy of disclosures)
- SEC: Comment letters continuing to focus on Indefinite reinvestment assertions

FASB – Disclosure Framework Project

- In response to the FAF’s post implementation review of FAS 109 and feedback from the SEC, the FASB added unremitted foreign earnings to its existing disclosure review initiative
- Foreign earnings: the FASB made a “tentative board decision” that the following income tax disclosures related to foreign earnings should be required:
 - Earnings disaggregated between domestic and foreign earnings for public and non-public entities
 - Foreign earnings would be further disaggregated for any country that is significant to total earnings
 - Domestic tax expense recognized in the period for taxes on foreign earnings
 - Undistributed foreign earnings that are no longer asserted to be indefinitely reinvested during the current period. Separate disclosure for any country that is significant
 - Disaggregation of the cumulative amount of indefinitely reinvested foreign earnings disclosure to the extent any country represents at least 10 percent of the disclosed amount

FASB – Disclosure Framework Project(cont.)

- Foreign earnings
 - The Board decided tentatively that the following disclosures would not be required:
 - Disaggregation of deferred tax liabilities recorded for unremitted foreign earnings by country
 - An estimate of the unrecognized deferred tax liability on the basis of simplified assumptions
 - Past events or current conditions that have changed management's plans for undistributed foreign earnings

SEC – Areas of Focus in 2015

Most frequent income tax comment letter topics:

- Effective tax rate presentation
- Indefinite reinvestment of foreign earnings
- Valuation allowance
- Uncertain tax positions

SEC – Areas of Focus in 2015 (cont.)

- Indefinite reinvestment assertions/foreign earnings
- Other disclosures
 - Expected increase in number of questions and requests for enhanced disclosures around:
 - Effective tax rates
 - Explaining fluctuations in the effective tax rate from the statutory rate
 - Volatility in the effective tax rate
 - Effective tax rates that do not change because of material changes in components are offsetting
 - More insight from qualitative disclosures above and beyond what is in the quantitative disclosures
 - Foreign earnings and the associated taxes
 - Source and extent
 - Pushback on boilerplate language regarding rate being impacted by mix of foreign earnings

SEC Comment Letters

*“Given your material international operations, please **enhance your disclosure** to address the following: Disclose the amount of foreign cash and cash equivalents you have as compared to your total amount of cash and cash equivalents as of next balance sheet date; and discuss the fact that if the foreign cash and cash equivalents are needed for your commitments in the U.S., you would be required to accrue and pay U.S. taxes to repatriate these funds but your intent is to permanently reinvest these foreign amounts outside the U.S. and your current plans do not demonstrate a need to repatriate the foreign amounts to fund your U.S. operations, if true. Refer to Item 303(a)(1) of Regulation S-K, SEC Release 33-8350 Section IV and Financial Reporting Codification 501.06.a.”*

SEC Comment Letters (cont.)

*“We note you have disclosed that it is not practicable to determine the tax amounts that would be payable if the \$[xx]million in undistributed foreign earnings were distributed to the U.S. parent. Please explain **why it is impracticable** to determine the tax amounts in-light-of the fact that you have determined and recorded a deferred tax liability for the \$[xx] million in undistributed foreign earnings not considered indefinitely reinvested.”*

*“We note that you repatriated \$[xx] billion of current year earnings from certain foreign subsidiaries during the fourth quarter. In this regard, we have the following comments: Please tell us and revise your disclosure to **fully explain** the reasons you repatriated \$[xx] billion of current year earnings from certain foreign subsidiaries; Please tell us and **revise your disclosure** to address how you concluded, in light of your repatriation in the fourth quarter, that you have the ability and intent to invest \$[xx] billion of accumulated foreign unremitted earnings indefinitely as of December 31.”*

SEC Comment Letters (cont.)

*“We note that your reconciliation of the effective tax rate includes a line item with the caption “Foreign dividends”. **Please tell us** whether or not this line item represents repatriation of foreign earnings during the periods presented. If it does, **please tell us** the nature, amount, timing and special circumstances surrounding each repatriation and tell us **how you evaluated** the criteria for the exception to recognition of a deferred tax liability in accordance with ASC 740-30-25-17 and 18 for undistributed earnings that are intended to be indefinitely reinvested. Please also **describe the type of evidence** that sufficiently demonstrates that remittance of earnings will be postponed indefinitely as disclosed on page [xx].”*

*“We note from page [xx] that at December 30, 2012 you hold a cumulative total of \$[xx] million of undistributed earnings in non-U.S. subsidiaries that you plan to reinvest outside the U.S. indefinitely. As we note that your cash and cash equivalents totaled \$[xx] million at that date, **please tell us** the amount of cash and equivalents and liquid investments held by your foreign subsidiaries at December 30, 2012 and **quantify the amount** that would not be available for use in the U.S. without incurring U.S. taxes.”*

SEC Comment Letters (cont.)

*“Based on your disclosure on page [xx] it does not appear that you repatriated any foreign earnings during fiscal 2013, though we note the relatively small impact therefrom in the tax rate reconciliation on page [xx]. However, you indicated that you repatriated \$[xx] million at year end in the CFO’s prepared **remarks of the earnings call transcript**. Please clarify or reconcile.”*

*“We note your disclosure on page [xx] states that you “have removed your election to permanently reinvest foreign earnings for 2011, 2010 and 2009.” We also understand that you may have repatriated some of these earnings in order to fund the redemption of the 1.75% convertible senior notes and the share repurchase in 2011. Please **confirm** whether our understanding is correct and **clarify** why you have not recorded deferred tax liabilities in 2011 related to these undistributed foreign earnings to comply with FASB ASC paragraphs 740-30-25-17 through 19.”*

SEC Comment Letters (cont.)

*We note on page F-25 that your fiscal 2013 **foreign income** before income taxes was **40% of your total income** before income taxes, and that the percentage of your foreign income has been increasing over the past three years. We further note on page F-27 that you had approximately **\$42.8 million of indefinitely reinvested earnings** of foreign subsidiaries as of December 31, 2013. If these foreign earnings are repatriated, they may be subject to U.S. income taxes and foreign withholding taxes. To the extent you have cash and cash equivalents and short-term investments held by foreign subsidiaries, please tell us and **provide draft disclosure** to be included in future filings of the **amount** of foreign cash and cash equivalents and short-term investments, and the potential income **tax consequences** of repatriating your undistributed earnings for which you have not already recorded a deferred tax liability. To the extent you do not intend to repatriate funds, please state this assertion in your disclosure. Refer to Item 303(a)(1) of Regulation S-K and Section IV of SEC Release 33-8350.*

PCAOB - Indefinite Reinvestment

PCAOB Inspection trends and themes – Income taxes

- Reviews continue to focus on audit evidence, procedures, and documentation with respect to judgments, estimates, assertions, and internal controls
- Estimates
 - Did not always identify and appropriately test key assumptions underlying significant judgments and estimates
 - Over reliance on discussions with client to support key assumptions
 - Insufficient documentation
- Internal controls
 - Insufficient evidence of testing of the control activities that constitute supervisory review

Indefinite Reinvestment Accounting Issues

Overview

- Guidance
 - 740-30-25-18(a) provides that a deferred tax liability is not recognized for “an excess of the amount of financial reporting over the tax basis of an investment on a foreign subsidiary or foreign corporate joint venture that is essentially permanent in duration.”
 - One of the few standards that speaks of management retaining evidence, in this case of reinvestment plans
 - Allows preparers to avoid recording a deferred tax liability in a framework that is generally seen as conservative
- Outside Basis Difference
 - Largest portion of the outside basis difference typically arises from unremitted earnings but includes differences rising from comprehensive income and other changes in the subsidiary’s equity

Indefinite Reinvestment Accounting Issues (cont.)

- Outside Basis Difference (cont.)
 - The difference between the book/tax basis in the investment represents a single outside basis difference
 - Entity should not record a DTA for one portion of the outside basis difference while not recording a DTL for another portion of the difference based on an indefinite reversal exception
 - Not meant to limit an entity's ability to assert that only a portion of the single outside basis difference is subject to the indefinite reversal exception
 - Entity can maintain a DTL on some, but not all, of the outside basis difference (whether or not such difference is caused by unremitted earnings or other factors) if its assertion is justified by the "evidence" and "plans" described in ASC 740-30-25-17

Indefinite Reinvestment Accounting Issues (cont.)

- Disclosure considerations
 - Consistency throughout the financial statements on statements and assertions
 - Ability to assert indefinite reinvestment and evidence relied upon
 - Changes in assertion
 - Quantification of earnings deemed indefinitely reinvested
 - Tax liability for earnings deemed indefinitely reinvested
 - Events that could cause indefinitely reinvested earnings to become taxable in the home jurisdiction
 - Jurisdictions where foreign earnings are accumulated
 - Implications on liquidity and capital resources

Indefinite Reinvestment Accounting Issues (cont.)

Question: Can an entity reverse its assertion in a period, due to facts and circumstances, and still have the ability to assert in a future period?

Indefinite Reinvestment Accounting Issues (cont.)

- Changes in an assertion
 - What were the triggering events that caused the change in assertion?
 - Could a similar situation happen in the future?
 - Are they earnings truly indefinitely reinvested or are they available under the right circumstances
 - Does the Company's business activities make asserting difficult?

Current economic environment – impact on ability to assert

- Are significant payments due near-term, such as debt or pension funding?
- Have there been any recent remittances?
- Will a US investment or acquisition necessitate financing by redeployment of foreign subsidiary funds?
- Have there been any defaults or debt covenant violations?
- Is there substantial doubt about the ability to continue as a going concern?

What are External Auditors Looking for?

Specific plans for indefinite reinvestment assertions must be documented and maintained by management:

- When evaluating specific plans consider the following:
 - Forecasts and budgets of parent and subsidiary for both long & short term
 - Financial requirements of both parent and subsidiary for long & short term
 - Past history of dividend actions
 - Planned acquisitions
 - Tax consequences of a decision to remit or reinvest
 - Remittance restrictions in a loan agreement of a subsidiary
 - Remittance restrictions imposed by foreign governments that result in forced reinvestment in the country
 - Any U.S. government programs designed to influence remittances

What are External Auditors Looking to do?

- Demonstrate their knowledge of a Company's organizational structure including which entities are asserting indefinite reinvestment versus those that do not in their documentation
- Demonstrate their knowledge of management's specific plans or other evidence supporting their indefinite reinvestment assertion
- Test the reasonableness of management's assertion
 - Test projections of U.S. and foreign uses of cash
 - Consideration of existing loan agreements for restrictions or other barriers to financing
 - A schedule of actual or deemed distributions to ensure assertions (current or prior) has not been violated
 - Identify entities that generate income that may be currently taxable (e.g., CFCs with Sub-part F income) to ensure management truly has ability to defer tax on earnings

What are External Auditors Looking to do? (cont.)

- Assess the sufficiency and transparency of disclosures
- Test the recorded balances
 - Audit the measurement of deferred tax liabilities on outside basis
 - Test mathematical accuracy of analysis
 - Agree amounts to financial statements / other analyses

Other Repatriation Techniques

Sale of IP or Prepaid License of IP as Repatriation Valve

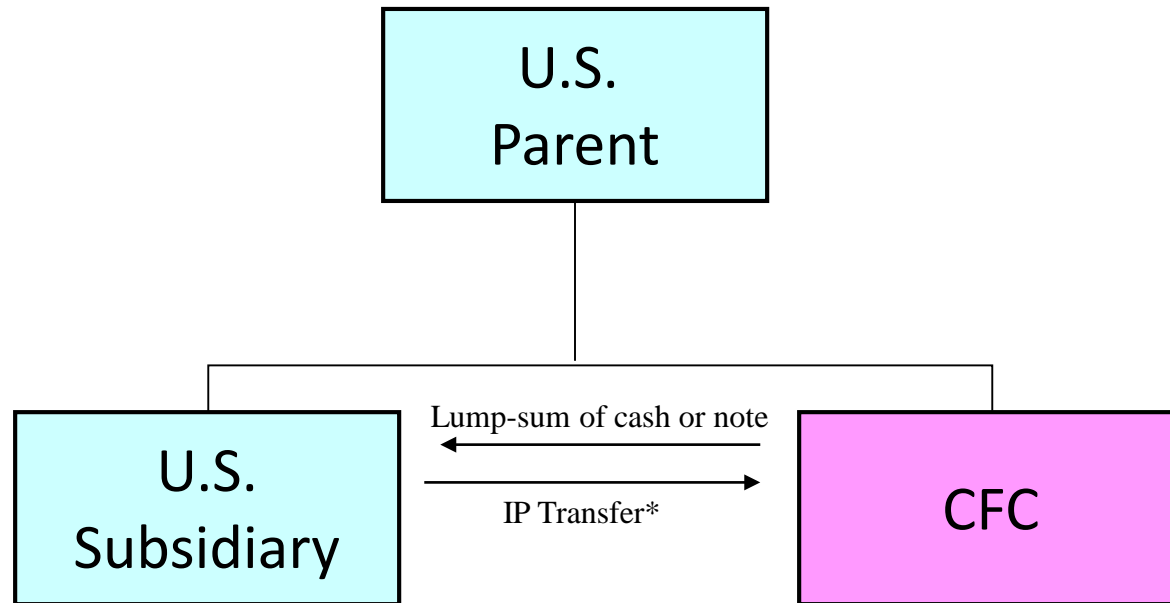

* Assume U.S. Subsidiary has previously licensed IP for annual royalty payments. In 2015, U.S. Subsidiary transfers IP for a term of years in exchange for lump-sum payment.

Tax Treatment of IP Sale vs. License

1. Sale if: Exclusive, perpetual, irrevocable, right to sublicense, unlimited field of use, broad scope of license terms, and unrestricted geographic territory.
2. License if: Non-exclusive, limited term (not perpetual), revocable, no right to sublicense, restricted field of use, narrow scope of license terms, and restricted geographic territory.

Tax Treatment of IP Sale vs. License (cont.)

- Character, source and basis recovery depend on whether transaction is characterized as sale or license. Also CFC's deduction or amortization for U.S. E&P purposes.
- Sale typically generates capital gain, while license generates ordinary income. Note: Contingent Payment Sale can be treated as license.
- Tax law follows substance rather than form. "License" may be a true sale.
- Whether transfer of IP rights constitutes sale or license determined under "all substantial rights" test.
- Transfer of IP rights constitutes sale only if exclusive and perpetual right to use IP and to make, use, and sell the claimed technology or product in a particular geographic territory is transferred.
- "Transfer" of non-exclusive right to use IP, particularly for a period less than estimated useful life of the asset, generally results in license of the asset. Payments received by transferor / licensor constitute royalties (ordinary income).

Summary of Anticipated U.S. Tax Results

	Sale to a Foreign Entity (Non-Contingent)	License to a Foreign Entity
Foreign Tax Credit	Generally Passive Basket	General Limitation Basket
Source	Based on Residence of Seller (U.S.)	Based on Location of IP Use (Foreign)
Section 956	Concern if U.S. rights to IP Transferred	N/A
Income Inclusion	Current (or subject to installment sale rules)	Current or Periodic
Treatment of Intercompany Note	<ul style="list-style-type: none"> - Debt/Equity Issues - Terms of Note - Ability to Service - Cash Flow Coverage 	Same issues
Impact on E&P of CFC	Amortize over IP life	Reduce E&P as paid

Section 304 Transactions – the Basic

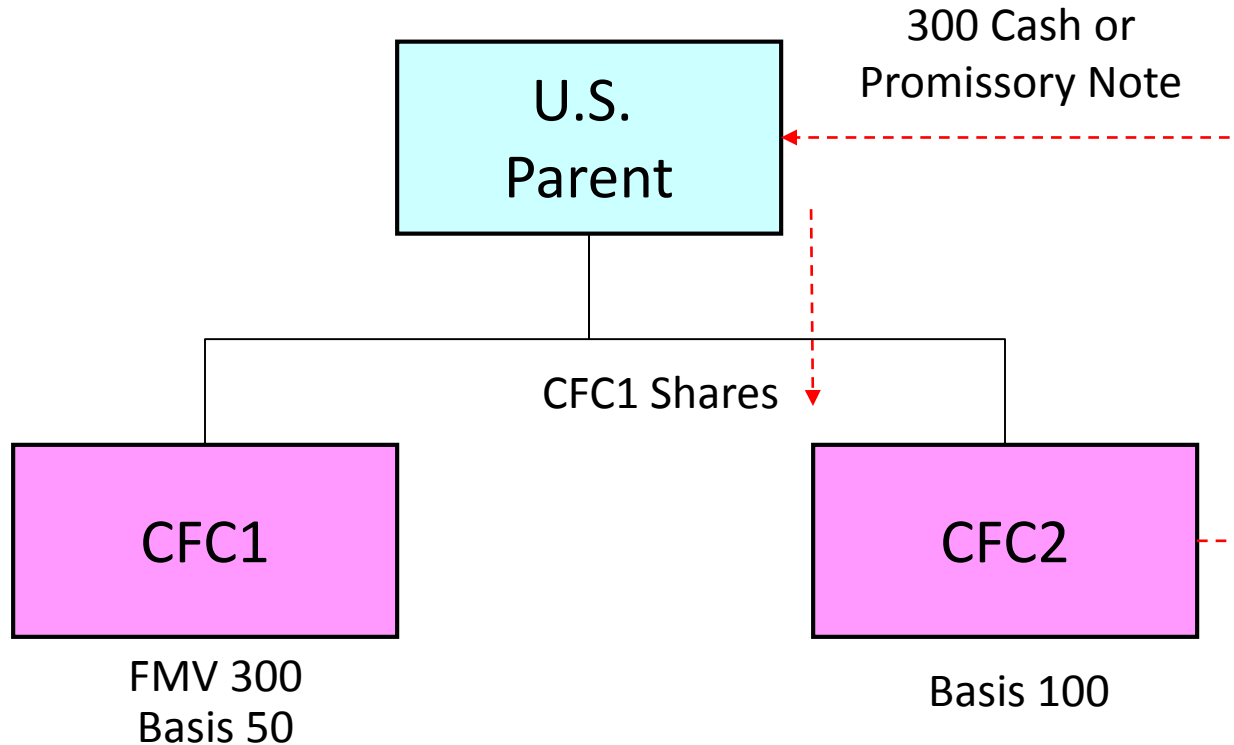

CFC2 acquires CFC1 shares from U.S. Parent for 300.

Section 304 Transactions – the Construct

1. U.S. Parent transfers CFC1 (issuing corporation) shares to CFC2 (acquiring corporation) in exchange for property.
2. Treated as if:
 - a. U.S. Parent had transferred CFC1 to CFC2 in exchange for new shares of CFC2 in a transaction to which Section 351 applies

and
 - b. CFC2 had redeemed shares it was treated as issuing.

Accordingly, if CFC2 was worth 700, CFC2 would be treated as issuing 30% of its shares ($300/300 + 700$) to U.S. Parent and then immediately redeeming those CFC2 shares.

Section 304 Transactions – the Math

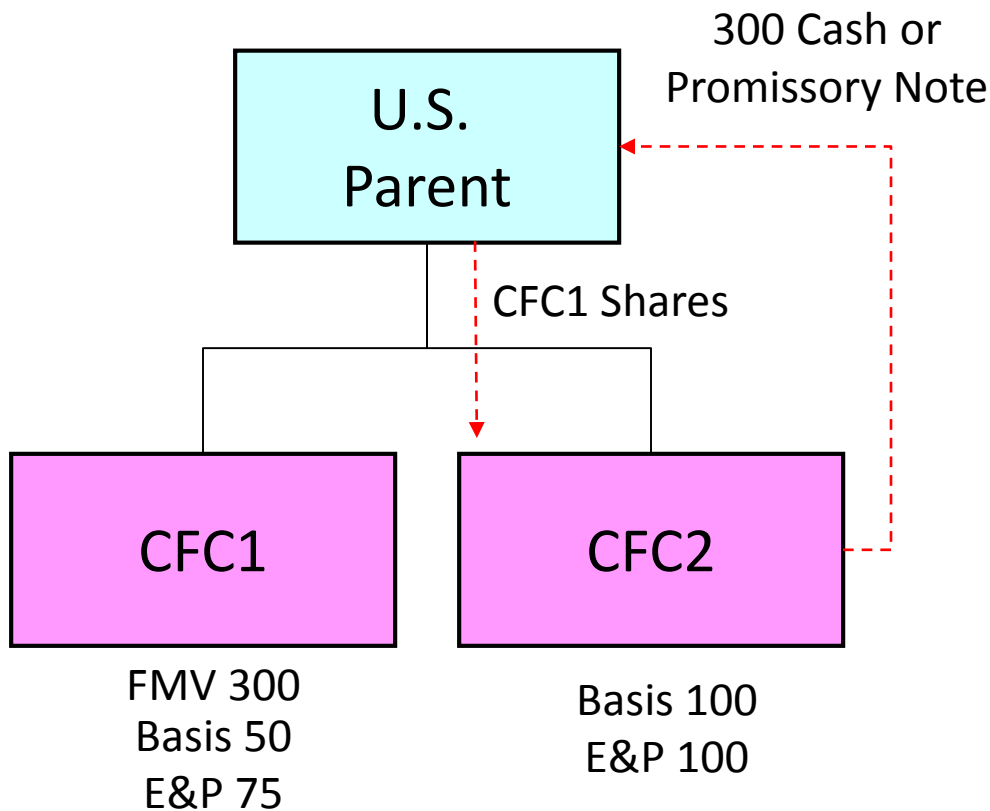

The Construct: U.S. Parent is treated to have contributed CFC1 shares to CFC2 in exchange for CFC2 shares worth 300. Immediately, CFC2 is treated to redeem those CFC2 shares for 300 cash.

Tax Effect of the Redemption:

1. Dividend to extent of CFC2 E&P (100).
2. Dividend to extent of CFC1 E&P (75).
3. Return of basis (to extent of original basis in CFC1 (50)).
4. Balance (75)?

Notice 2012-15 turns Section 367(a) GRA requirement on in case of deemed Section 351 transfer of CFC1 to CFC2.

Section 304 Transactions – Added Complexity

Temp. Treas. Reg. § 1.367(a)-9T. were issued to address basis calculations in cross border Section 304 transactions. The rules were extended and modified by Notice 2012-15. These rules impact:

- U.S. Parent's dividend income and potential gain.
- Basis of U.S. Parent in CFC2, and basis of CFC2 in CFC1.

Factors:

- U.S. Parent's basis in CFC1 and in CFC2.
- CFC1 and CFC2 total E&P.
- Lower-tier subsidiaries of CFC1 – stock basis, FMV, and E&P.

Section 304 Transactions – Temp. Treas. Reg. § 1.367(a)-9T Application

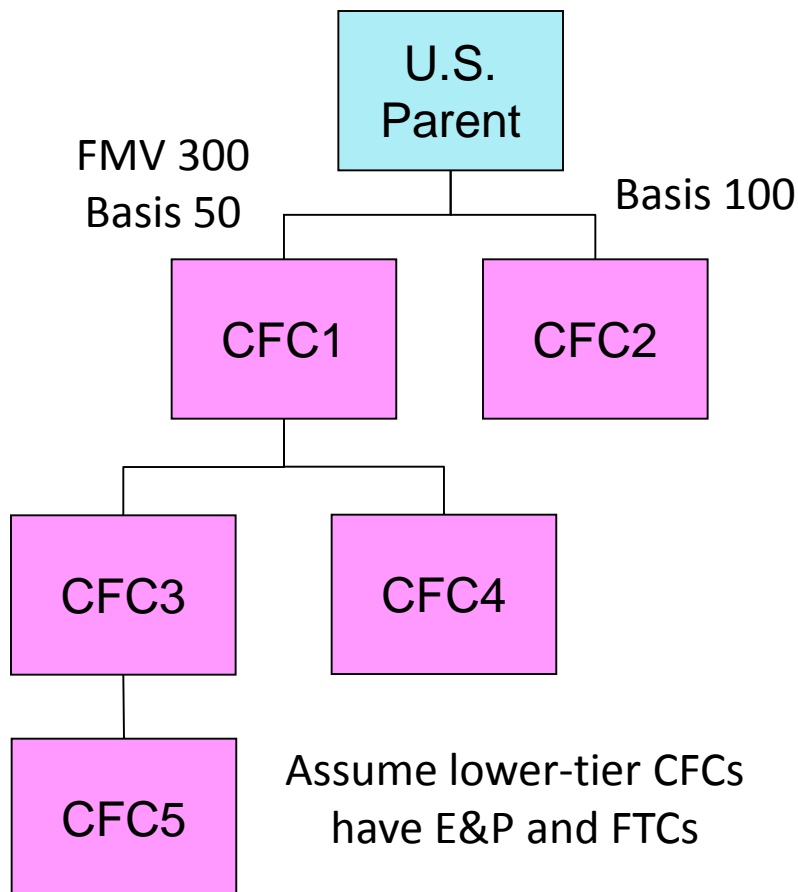

Depending upon factors listed on prior page, sale of CFC1 by U.S. Parent to CFC2 could result in gain at U.S. Parent which is not dividend equivalent.

Key Issues for consideration:

1. Basis in first tier CFCs.
2. E&P and FTC pools in all CFCs.
3. Lack of GRA triggers Section 1248 in CFC1 (which includes E&P and FTCs at lower-tier (CFCs). But can result in more than 300 income.
4. Location of PTI.

Holding Company Structures

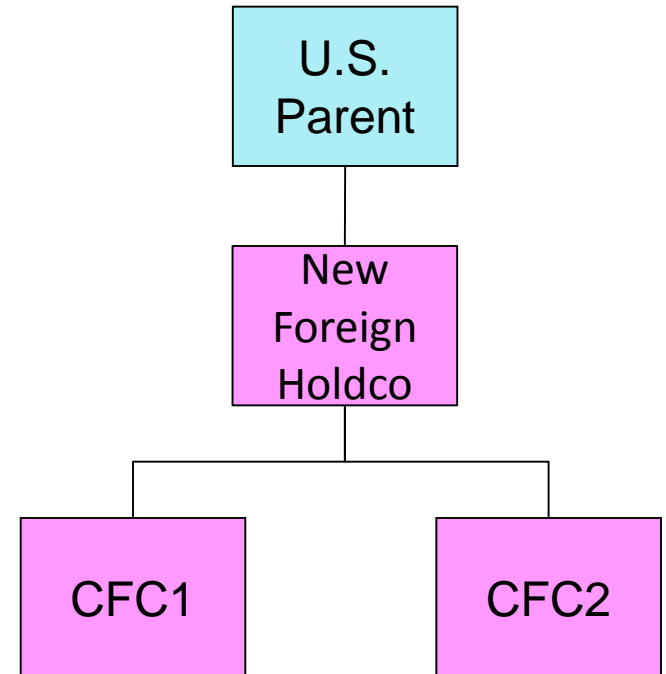
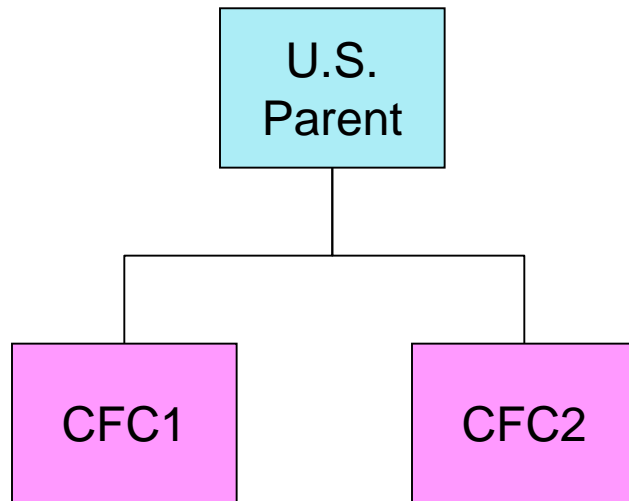

Issues for consideration:

1. Rationale for new foreign holding company
2. GRAs and potential future triggering events.
3. U.S. Parent basis in new Foreign Holdco shares (See Section 358 regulations on “tracing” as compared to averaging)
4. Upstream movements of cash.

Other Issues/Techniques

1. Treasury severely curtailed the use of certain outbound reorganization techniques following acquisition of U.S. Target with new proposed regulations under 367(a) and (d).
2. Treasury/IRS continuing concerns over repatriation.
3. Continuing role of Section 956?
4. Tax Reform?

Thank You

- Questions? Comments?

About this presentation

This presentation contains general information only and the respective speakers and their firms are not, by means of this presentation, rendering accounting, business, financial, investment, legal, tax, or other professional advice or services. This presentation is not a substitute for such professional advice or services, nor should it be used as a basis for any decision or action that may affect your business. Before making any decision or taking any action that may affect your business, you should consult a qualified professional advisor. The respective speakers and their firms shall not be responsible for any loss sustained by any person who relies on this presentation.